

# Table of Contents

<b>Introduction</b>	<b>4</b>
Preface .....	4
Hardware Requirements.....	5
Software Installation .....	6
License Agreement/Disclaimer.....	6
<b>Mode of Operation</b>	<b>8</b>
Overview.....	8
Example Circuits.....	8
General Purpose Schematic Driven SPICE .....	9
Externally Generated Netlists .....	10
Efficiency Report .....	11
Command Line Switches.....	13
<b>Schematic Capture</b>	<b>14</b>
Basic Schematic Editing .....	14
Label a node name.....	17
Schematic Colors .....	19
Placing New Components .....	20
Programming Keyboard Shortcuts .....	20
PCB Netlist Extraction .....	21
Editing Components .....	22
Edit a Visible Attribute .....	22
Specialized Component Editors.....	23
General Attribute Editor .....	24
Creating New Symbols.....	26
Symbol Editing Overview .....	26
Drawing the body .....	27
Adding the Pins .....	27
Adding Attributes.....	28
Attribute Visibility.....	30
Automatic Symbol Generation .....	31
Hierarchy .....	32
Hierarchy Overview.....	32
Rules of Hierarchy.....	32
Navigating the Hierarchy.....	33
<b>Waveform Viewer</b>	<b>35</b>
Waveform Viewer Overview .....	35
Data Trace Selection .....	35
Zooming.....	40
Waveform Arithmetic .....	40
User-Defined Functions.....	47
Axis Control .....	48
Plot Panes .....	48
Color Control.....	49
Attached Cursors.....	50
Save Plot Configurations.....	54
Fast Access File Format.....	55

## LTspice® 57

Introduction.....	58
Circuit Description.....	58
General Structure and Conventions.....	59
Circuit Element Quick Reference.....	62
Dot Commands.....	63
C. Simulator Directives -- Dot Commands.....	63
.AC -- Perform an Small Signal AC Analysis Linearized About the DC Operating Point. .....	64
.BACKANNO -- Annotate the Subcircuit Pin Names to the Port Currents.....	65
.DC -- Perform a DC Source Sweep Analysis .....	65
.END -- End of Netlist.....	66
.ENDS -- End of Subcircuit Definition .....	66
.FOUR -- Compute a Fourier Component after a .TRAN Analysis .....	66
.FUNC -- User Defined Functions.....	67
.FERRET -- Download a File Given the URL.....	68
.IC -- Set Initial Conditions .....	68
.INCLUDE -- Include Another File.....	69
.LIB -- Include a Library.....	70
.LOADBIAS -- Load a Previously Solved DC Solution.....	73
.MEASURE -- Evaluate User-Defined Electrical Quantities.....	73
.MODEL -- Define a SPICE Model.....	77
.NET -- Compute Network Parameters in a .AC Analysis.....	78
.NODESET -- Supply Hints for Initial DC Solution .....	79
.NOISE -- Perform a Noise Analysis.....	80
.OP -- Find the DC Operating Point.....	81
.OPTIONS -- Set Simulator Options .....	81
.PARAM -- User-Defined Parameters.....	85
.SAVE -- Limit the Quantity of Saved Data .....	90
.SAVEBIAS -- Save Operating Point to Disk .....	90
.STEP -- Parameter Sweeps.....	91
.SUBCKT -- Define a Subcircuit.....	92
.TEMP -- Temperature Sweeps .....	93
.TF -- Find the DC Small Signal Transfer Function.....	94
.TRAN -- Perform a Nonlinear Transient Analysis .....	94
.WAVE -- Write Selected Nodes to a .Wav File. ....	95
Transient Analysis Options.....	96
.TRAN Modifiers.....	96
UIC .....	96
startup .....	96
steady.....	97
nodiscard.....	97
step .....	98
Circuit Elements .....	98
A. Special Functions. ....	98
B. Arbitrary behavioral voltage or current sources.....	101
C. Capacitor .....	107
D. Diode .....	110
E. Voltage Dependent Voltage Source .....	113
F. Current Dependent Current Source.....	115
G. Voltage Dependent Current Source .....	116
H. Current Dependent Voltage Source .....	117
I. Current Source.....	118
J. JFET transistor.....	123
K. Mutual Inductance .....	126

L. Inductor .....	127
M. MOSFET .....	132
O. Lossy Transmission Line.....	143
Q. Bipolar transistor .....	145
Parameters .....	151
References: .....	158
R. Resistor .....	158
S. Voltage Controlled Switch .....	159
T. Lossless Transmission Line.....	161
U. Uniform RC-line .....	161
V. Voltage Source .....	163
W. Current Controlled Switch.....	167
X. Subcircuit.....	169
Z. MESFET transistor.....	169
<b>Control Panel</b> .....	<b>171</b>
Accessing the Control Panel .....	171
Compression.....	171
Operation.....	173
Save Defaults .....	175
SPICE .....	177
Netlist Options .....	178
Hacks.....	179
Drafting Options.....	180
Internet Options .....	182
<b>FAQs</b> .....	<b>184</b>
Program Updates .....	184
Transformer Models .....	185
Third-party Models.....	186
Inductor Models .....	189
MOSFET Models .....	190
License and Distribution .....	192
Circuit Efficiency Calculation .....	193
Custom Symbols .....	194
Memory Problems .....	194
Model Compatibility .....	196
SPICE Netlist.....	196
Exporting/Merging Waveform Data .....	196
Running Under Linux.....	198
What about a Paper Manual? .....	199
What about a Users' Group? .....	199
<b>LTspice IV Overview</b> .....	<b>200</b>
<b>SPICE Error Log Command</b> .....	<b>201</b>
<b>Web Update</b> .....	<b>202</b>

# Introduction

## Preface

Do we need another SPICE?

Analog circuit simulation has been inseparable from analog IC design. SPICE simulators are the only way to check circuitry prior to integration onto a chip. Further, the SPICE simulation allows measurements of currents and voltages that are virtually impossible to do any other way. The success of these analog circuit simulators has made circuit simulation spread to board level circuit design. It is easier in many cases to simulate rather than breadboard, and the ability to analyze the circuit in the simulation for performance and problems speeds the design of well-understood, robust circuits.

Given the number of commercially available SPICE simulators why should a new simulator be written? Because certain analog functions are extremely difficult to simulate with commercially available SPICE simulators. Switch-mode power supplies have fast high frequency switching square waves as well as slow overall loop response. This means simulations must run for thousands to hundreds of thousands of cycles in order to see the overall response of a switching regulator. Commercially available SPICE's simply take too long for this to be a useful simulation method. Simulation times for a switch-mode power supply must be in minutes not hours for a simulator to be useful.

There have been analog circuit simulation methods that have shown some success in speeding up switch mode power supply simulation but at a cost of making simplifying assumptions which don't allow arbitrary control logic and fully simulate the complexity of the switching waveforms. A new SPICE with integrated logic primitives that perform the switch mode control provides a better answer. It can give fast simulation times, yield detailed waveforms, and still allows the flexibility for arbitrary circuit modifications.

LTspice is a new SPICE that was developed to simulate analog circuits fast enough to make simulation of complex SMPS systems interactive. Incorporated into the new SPICE are circuit elements to model practical board level components. Capacitors and inductors can be modeled with series resistance and other parasitic aspects of their behavior without using sub-circuits or internal nodes. Also, a simulation circuit element was developed for power MOSFET's that accurately exhibits their usual gate charge behavior without using sub-circuits or internal nodes. Reducing the number of nodes the simulator

needs to solve significantly reduces the computation required for a given simulation without compromising the accuracy or detail of the switching waveforms. Another benefit of these new simulation devices is that convergence problems are easier to avoid since they, like the board level component the model, have finite impedance at all frequencies.

Modern switch mode power supplies include controller logic with multiple modes of operation. For example, devices may change from pulse switch modulation to burst-mode or to cycle skipping depending on the circuit's operation. An original new mixed-mode compiler and simulator were written into LTspice that allows these products to be realistically modeled in a computationally fast manner.

But despite LTspice's close association with SMPS design, it not a SMPS-specific SPICE but simply a SPICE program fast enough to simulate a SMPS interactively.

There are currently approximately fifteen hundred Linear Technology products modeled in LTspice. The program is freely downloadable from the Linear Technology website and is a high-performance, general-purpose SPICE simulator. Included are demonstration files that allow you to watch step-load response, start-up and transient behavior on a cycle-by-cycle basis. Included with the SPICE is a full-featured schematic entry program for entering new circuits.

## Hardware Requirements

LTspice IV runs on PC's running Windows 98, 2000, NT4.0, Me, XP, Vista, or Windows 7. Since a simulation can generate many megabytes of data in a few minutes, free hard disk space (>10GB) and large amount of RAM (>1GB) are recommended. Basically, the program can run on any PC with Windows 98 or above, but the simulation may not finish if there is not enough hard disk space.

There are two bugs in the Windows OS that give some LTspice users trouble. Both bugs relate to Windows hiding the true file name and path of files. Since it is common to use foreign files in LTspice, this can cause confusion.

To circumvent these bugs, please follow the following steps. First, in Windows Explorer, goto to folder options, view, and uncheck "Hide extensions for known file types." Second, on Vista or Windows 7 turn of User Account

Control(UAC). UAC can cause the path of files to be different depending on which application is used to view the directory. This breaks the fundamental paradigm of storing files in a computer as it is strongly recommended that you disable UAC. Otherwise it might appear that you have lost files for no apparent reason.

LTspice IV will also run on Linux. The program has been tested on Linux RedHat 8.0 with WINE version 20030219.

## Software Installation

LTspice IV can be downloaded from the LTC website <http://www.linear.com>. A direct link to the distributed file is <http://ltspice.linear.com/software/LTspiceIV.exe>. The file LTspiceIV.exe is a self-extracting gzipped file that installs LTspice IV as it extracts.

LTspice IV is updated often. After LTspice IV is initially installed, you can use a built-in `update` menu command that will bring your installation to the current revision level if you have access to the web. The update process will first download a master index file from Linear's website that has the size and checksum of each file in the distribution. If there is a file missing, of a different size, or a difference between the local checksum and the one from the index file, then that file will be updated automatically. Component databases are merged in the update process so if you've added devices to your installation, those additions won't be lost when you run the automatic update utility.

## License Agreement/Disclaimer

LTspice -- License Agreement/Disclaimer

Copyright © 2001-2009, Linear Technology Corporation. All rights reserved.

LTspice is Linear Technology Corporation's switch mode power supply synthesis and analog circuit simulation software.

This software is copyrighted. You are granted a non-exclusive, non-transferable, non-sublicenseable, royalty-free right

solely to evaluate LTC products and also to perform general circuit simulation. Linear Technology Corporation owns the software. You may not modify, adapt, translate, reverse engineer, decompile, or disassemble the software executable(s) or models of LTC products provided. We take no responsibility for the accuracy of third party models used in the simulator whether provided by LTC or the user.

While we have made every effort to ensure that LTspice operates in the manner described, we do not guarantee operation to be error free. Upgrades, modifications, or repairs to this program will be strictly at the discretion of LTC. If you encounter problems installing or operating LTspice for the purpose of selecting and evaluating LTC products, you may obtain technical assistance by calling our Applications Department at (408) 432-1900, between 8:00 am and 5:00 pm Pacific time, Monday through Friday. We do not provide such technical support for general circuit simulations that are not for the evaluation of LTC products. Because of the great variety of PC-compatible computer systems, operating system versions, and peripherals currently in use, we do not guarantee that you will be able to use LTspice successfully on all such systems. If you are unable to use LTspice, LTC does provide design support for LTC switching regulator ICs by whatever means necessary.

The software and related documentation are provided "AS IS" and without warranty of any kind and Linear Technology Corporation expressly disclaims all other warranties, express or implied, including, but not limited to, the implied warranties of merchantability and fitness for a particular purpose. Under no circumstances will LTC be liable for damages, either direct or consequential, arising from the use of this product or from the inability to use this product, even if we have been informed in advance of the possibility of such damages.

Redistribution of this software is permitted as long as it is distributed in its entirety, with all documentation, example files, symbols, and models without modification or additions.

This program is specifically not licensed for use by semiconductor manufacturers in the promotion, demonstration or sale of their products. Specific permission must be obtained from Linear Technology for the use of LTspice for these applications.

# Mode of Operation

## Overview

LTspice IV has two basic modes of driving the simulator:

1. Use the program as a general-purpose schematic capture program with an integrated simulator. Menu commands File=>New, and File=>Open(file type .asc)
2. Feed the simulator with a handcrafted netlist or a foreign netlist generated with a different schematic capture tool. Menu command File=>Open(file type .cir)

LTspice IV is intended to be used as a general purpose schematic capture program with an integrated SPICE simulator. The idea is you draw a circuit(or start with an example circuit that's already drafted) and observe its operation in the simulator. The design process involves iterating the circuit until the desired circuit behavior is achieved in simulation. Earlier versions of LTspice included a synthesizer that would attempt to divine a SMPS design from a user-supplied specification, but that mode of operation has been obsoleted.

The schematic is ultimately converted to a textual SPICE netlist that is passed to the simulator. While the netlist is usually extracted from a graphical schematic drafted in LTspice, an imported netlist can be run directly without having a schematic. This has several uses: (i) Linear Technology's filter synthesis program, FilterCAD, can synthesize a netlist for LTspice to simulate the time domain or frequency response of a filter. (ii) it simplifies benchmarking LTspice against other SPICE programs (iii) professionals historically experienced with SPICE circuit simulators are familiar with working directly with the textual netlists because schematic capture was not integrated with SPICE simulators in older systems.

## Example Circuits

There are several resources of example circuits for LTspice IV. There is a directory typically installed at C:\Program Files\LTC\LTspiceIV\examples\Educational that gives numbers non-commercial examples of SPICE simulations that illustrate different analysis types, methods or program features. In the directory C:\Program Files\LTC\ LTspiceIV \examples\jigs there



is an example simulation for every Linear Technology device with a macromodel in LTspice IV. Note that these jig circuits are often only test jigs for the macromodel, not necessarily recommended reference designs. Most importantly, your Linear Technology office can probably give you design support specific for your application needs.

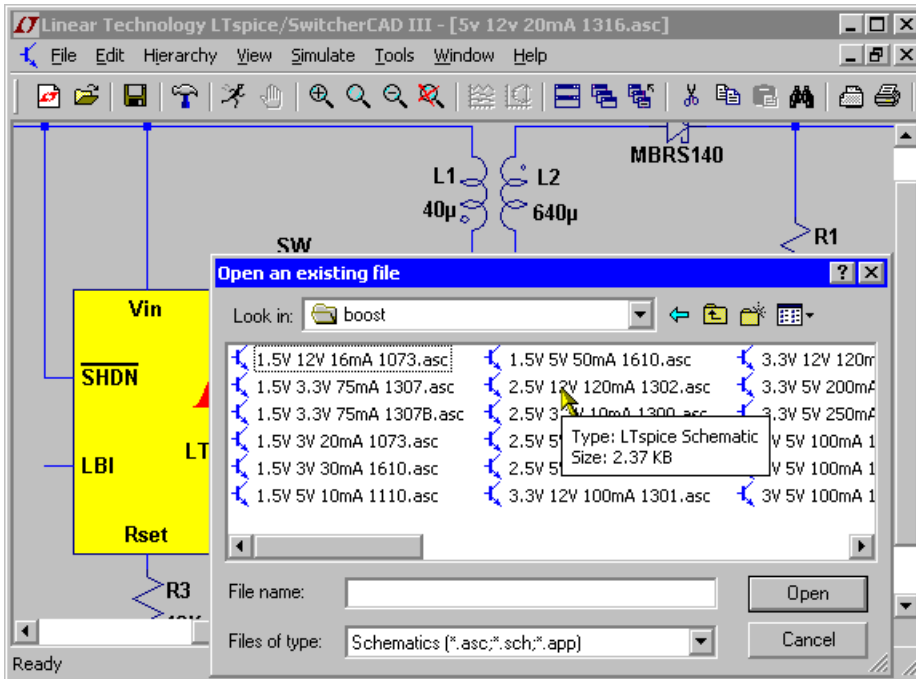

## General Purpose Schematic Driven SPICE

You are free to use LTspice IV as a general-purpose schematic capture/SPICE program. This is useful not only for SMPS design, but many aspects of analog engineering. The example circuits typically installed in the directory C:\Program Files\LTC\LTspiceIV\examples\Educational\ illustrate various LTspice capabilities.

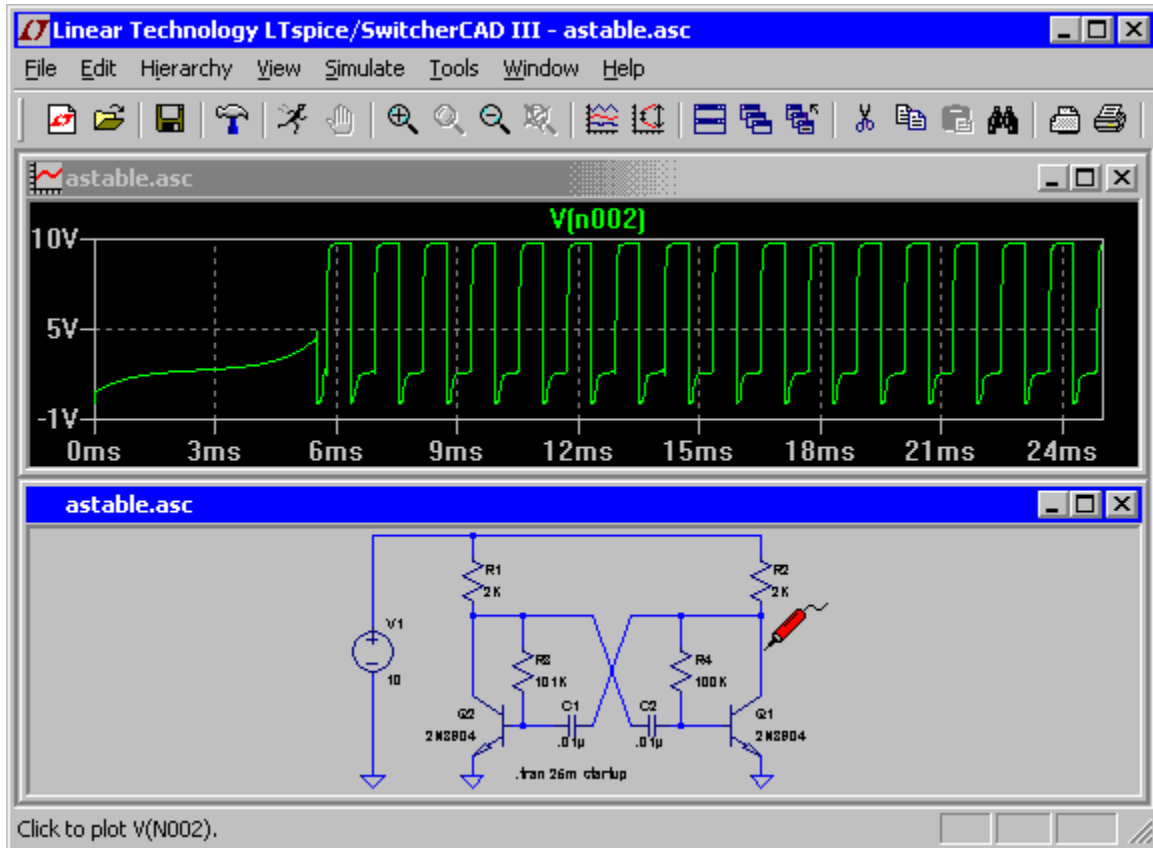

## Externally Generated Netlists

You can open netlists generated either by hand or by other schematic capture programs. These files usually have a filename extension of ".cir", but ".net" and ".sp" are understood. The ASCII editor used for netlist files supports unlimited file size and unlimited undo/redo. The menu command Tools=>Color Preferences can be used to adjust the colors used in the ASCII editor.

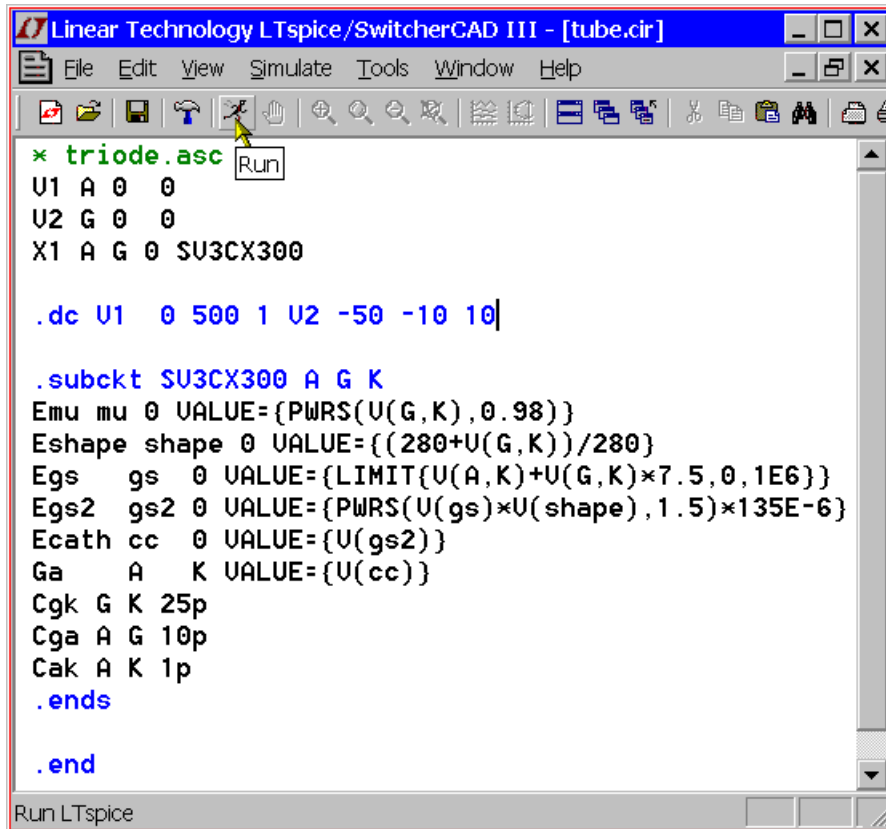

```
* triode.asc
U1 A 0 0
U2 G 0 0
X1 A G 0 SU3CX300

.dc U1 0 500 1 U2 -50 -10 10

.subckt SU3CX300 A G K
Emu mu 0 VALUE={PWRS(U(G,K),0.98)}
Eshape shape 0 VALUE={{(280+U(G,K))/280}
Egs gs 0 VALUE={LIMIT(U(A,K)+U(G,K)*7.5,0,1E6)}
Egs2 gs2 0 VALUE={PWRS(U(gs)*U(shape),1.5)*135E-6}
Ecath cc 0 VALUE={U(gs2)}
Ga A K VALUE={U(cc)}
Cgk G K 25p
Cga A G 10p
Cak A K 1p
.ends
.end
```

## Efficiency Report

It is possible to obtain an efficiency report from a DC-DC converter from a time domain .tran analysis that contains the keyword "steady". After a steady state simulation, an efficiency report can be made visible on the schematic as a block of comment text:

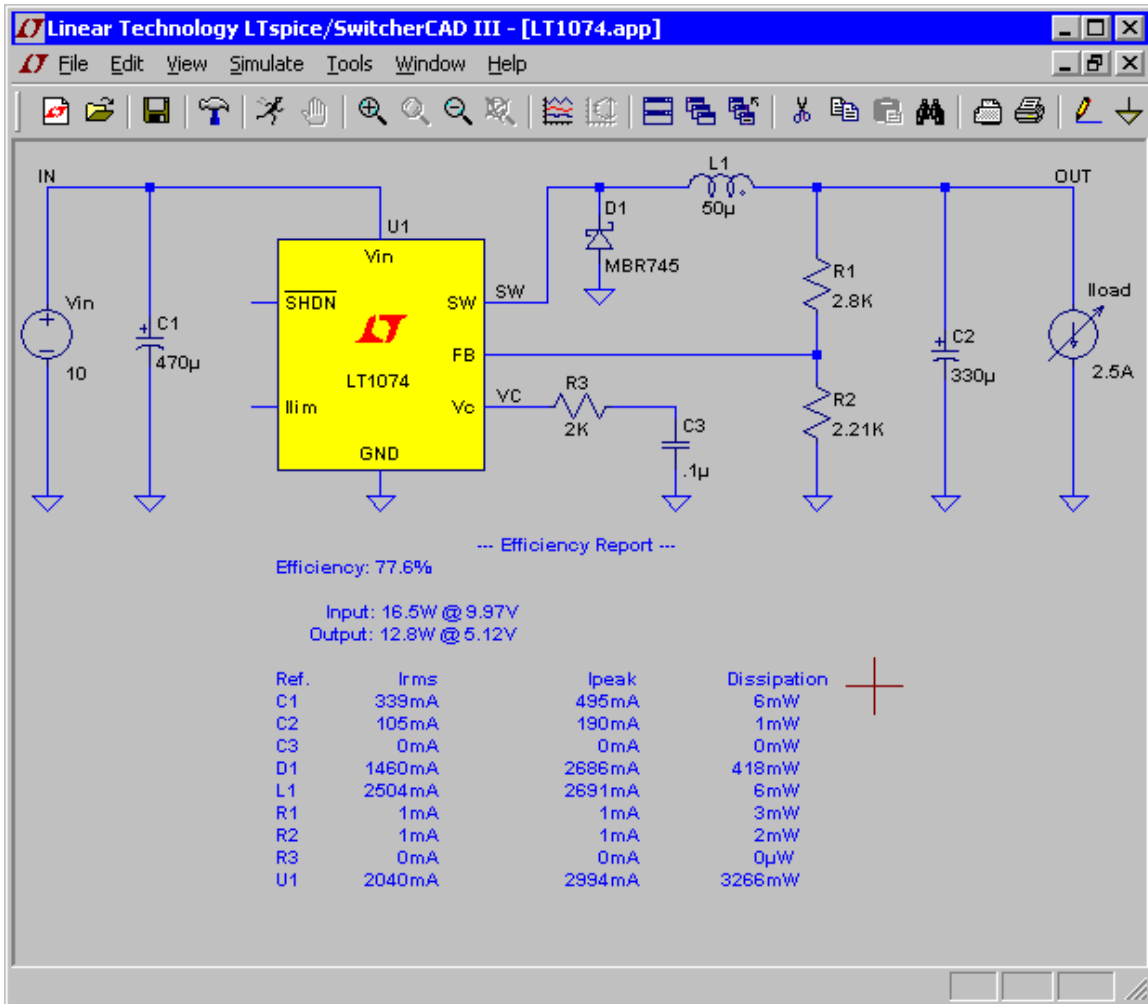

The efficiency of the DC-DC converter is derived in the following manner. In order to identify the input and output, there must be exactly one voltage source and one current source. The voltage source is assumed to be the input while the current source is assumed to be the output. The circuit is run until steady state is sensed by the simulator. This requires the SMPS macromodels to be written with information on how to detect steady state. Usually this is detected by noting when the error amp current, averaged over a clock cycle, diminishes to a small value for several cycles. Then at a clock edge, the energy stored in each reactance is noted and the simulation is run for another ten clock cycles but now integrating the dissipation in every device. At the clock edge of the last cycle, the energy stored in every reactance is noted again and the simulation is stopped. The efficiency is reported as the ratio of output power delivered to the load by the input power sourced by the input voltage after making an adjustment for the change in energy

stored in the reactances. Since the dissipation of each device was also noted, it is possible to look how close the energy checksum is to zero.

You can usually compute efficiency of SMPS circuits you draft yourself by using checking the "Stop simulating if steady state is detected" on the Edit Simulation Command editor. After the simulation, use the menu command View=>Efficiency Report.

Automatic detection of steady state doesn't always work. Sometimes the criteria for steady state detection is too strict and sometimes too lenient. You then either adjust the option parameter sstol or simply interactively set the limits for the efficiency integration.

## Command Line Switches

The following table summarizes the command line switches understood by the LTspice executable(scad3.exe):

<b>Flag</b>	<b>Description</b>
-ascii	Use ASCII .raw files. Seriously degrades program performance.
-b	Run in batch mode. E.g. "scad3.exe -b deck.cir" will leave the data in file deck.raw
-big	Start as a maximized window.
-encrypt	Encrypt a model library. For 3 <sup>rd</sup> parties wishing to allow people to use libraries without revealing implementation details. Not used by Linear Technology Corporation models.
-FastAccess	Batch conversion of a binary .raw file to Fast Access format.
-ini <path>	Specify an .ini file to use other than %WINDIR%\scad3.ini
-max	Synonym for -big
-netlis	Batch conversion of a schematic to a netlist.

t

- nowine Prevent use of WINE(Linux) workarounds.
- PCBnet Batch conversion of a schematic to a PCB format  
list netlist.
- regist Force LTspice to store user preferences, MRU,  
ry etc. in the registry instead of the  
%WINDIR%\scad3.ini file.
- Run Start simulating the schematic opened on the  
command line without pressing the Run button.
- SOI Allow MOSFET's to have up to 7 nodes even in  
subcircuit expansion.
- uninst Executes one step of the uninstallation process.  
all
- web Equivalent to executing menu command Tools=>Sync  
update Release.
- wine Force use of WINE(Linux) workarounds.

## Schematic Capture

### Basic Schematic Editing

The schematic capture program is used to create new schematics or modify the example circuits provided. The circuit size and depth of hierarchy is limited only by computer resources.

The program ships with approximately 800 symbols. These symbols cover most of LTC's power ICs, opamps, comparators, and many general-purpose devices for circuit design. You can also draw your own symbols for devices you wish to import into the program.

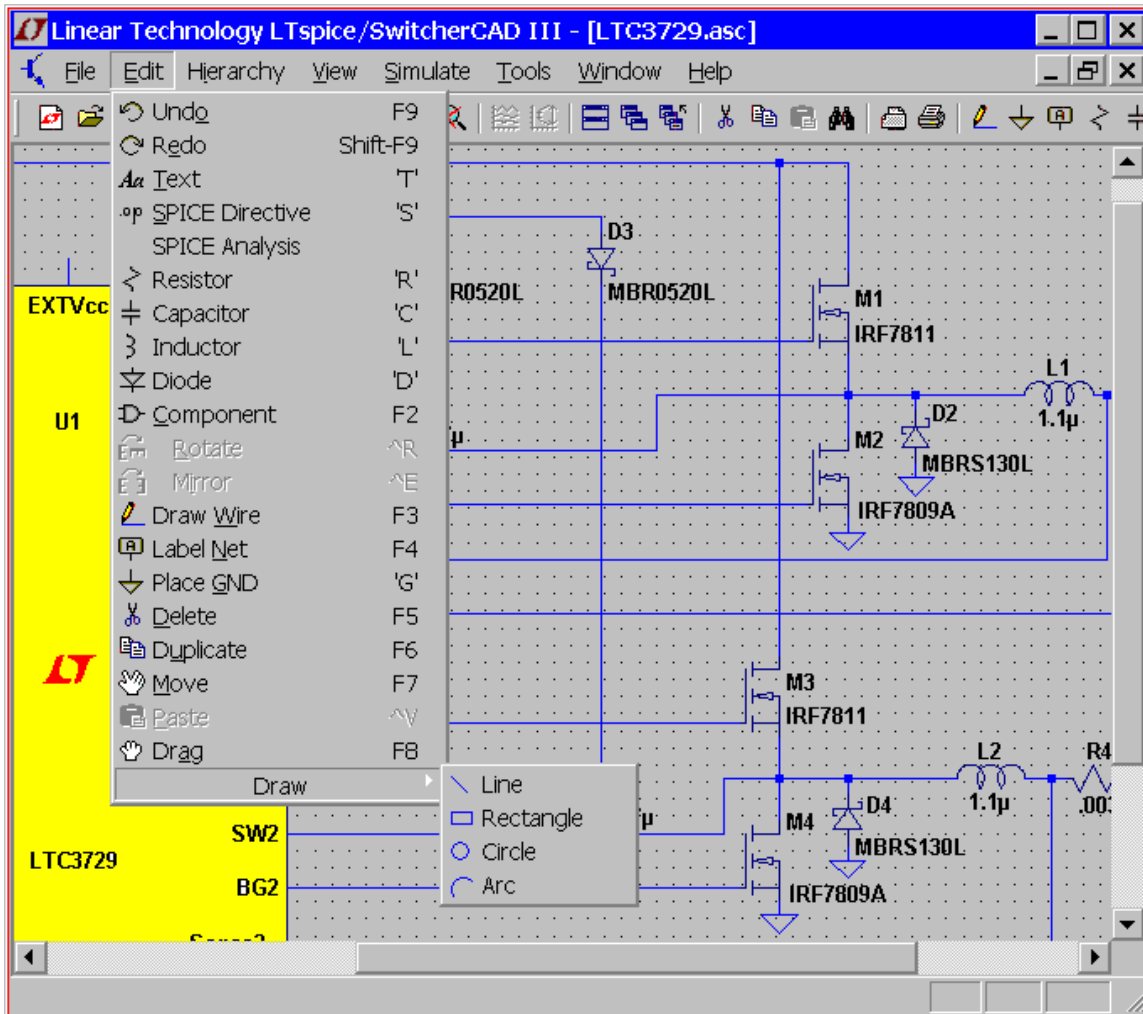

Unlike many schematic capture programs, this one was written explicitly for running SPICE simulations. This means that if you click on an object, the default behavior is to plot the voltage on that wire or current through that component, not select the object for editing or some other editing behavior which would then invalidate the simulation just performed. Hence, when you wish to move, mirror, rotate, drag or delete objects, first select the move, drag or delete command. Then you can select an object by clicking on it. You can select multiple objects by dragging a box about them. The program will stay in the move, drag, or delete mode until the right mouse button is clicked or the Esc key is pressed. All schematic edits can be undone or redone.

**Undo:** Undo the last command.

**Redo**: Redo the last Undo command.

**Text**: Place text on the schematic. This merely annotates the schematic with information. This text has no electrical impact on the circuit.

**SPICE Directive**: Place text on the schematic that will be included in the netlist. This lets you mix schematic capture with a SPICE netlist. It lets you set simulation options, include files that contain models, define new models, or use any other valid SPICE commands. You can even use it to run a subcircuit that you don't have a symbol for by stating an instance of the model (a SPICE command that begins with and 'X') on the schematic and including the definition.

**SPICE Analysis**: Enter/edit the simulation command.

**Resistor**: Place a new resistor on the schematic.

**Capacitor**: Place a new capacitor on the schematic.

**Inductor**: Place a new inductor on the schematic.

**Diode**: Place a new diode on the schematic.

**Component**: Place a new component on the schematic. The command brings up a dialog that lets you browse and preview the symbol database. This is a more general form of the Resistor, Capacitor, Inductor, and Diode commands.

**Rotate**: Rotate the sprited objects. Note this is grayed out when there are no objected sprited.

**Mirror**: Mirror the sprited objects. Note this is grayed out when there are no objected sprited.

**Draw Wire**: Click the left mouse button to start a wire. Each mouse click will define a new wire segment. Click on an existing wire segment to join the new wire with an existing one. Right click once to cancel the current wire. Right click again to quit this command. You can draw wires through components such as resistors. The wire will automatically be cut such that the resistor is now in series with the wire.

**Label Net**: Specify the name of a node so an arbitrary one isn't generated by the netlister for this node.

**Place GND**: Place a GROUND symbol. This is node "0", the global circuit common.



**Delete**: Delete objects by clicking on them or dragging a box around them.

**Duplicate**: Duplicate objects by clicking on them or dragging a box around them. You can copy from one schematic to another if they are both opened in the same invocation of LTspice IV. Start the Duplicate command in the window of the first schematic. Then make the second schematic the active window and type Ctrl-V.

**Move**: Click on or drag a box around the objects you wish to move. Then you can move those objects to a new location.

**Paste**: It is enabled in a new schematic window when objects were already selected with the 'Duplicate' command.

**Drag**: Click on or drag a box around the objects you wish to drag. Then you can move those objects to a new location and the attached the wires are rubber-band with the new location.

**Draw=>Line**: Draw a line on the schematic. Such lines have no electrical impact on the circuit, but can be useful for annotating the circuit with notes.

**Draw=>Rectangle**: Draw a rectangle on the schematic. This rectangle has no electrical impact on the circuit, but can be useful for annotating the circuit with notes.

**Draw=>Circle**: Draw a circle on the schematic. This circle has no electrical impact on the circuit, but can be useful for annotating the circuit with notes.

**Draw=>Arc**: Draw an arc on the schematic. This arc has no electrical impact on the circuit, but can be useful for annotating the circuit with notes.

**NOTE:** The graphical annotations to the schematic; lines, rectangles, circles, and arcs; snap by default to the same grid as the used for electrical contacts of wires and pins. Hold down the control key while positioning these to defeat this snap.

## **Label a node name**

Each node in the circuit requires a unique name. You can specify the name of a node so an arbitrary one isn't generated by the

netlister. Node "0" is the circuit global ground and is drawn with a special graphical symbol instead of the name "0".

There is also a graphical symbol defined for node "COM", but this node has no special significance. That is, it's not the SPICE global common and it's not even a global node. It's just sometimes convenient to have a graphical symbol associated with a node distinct from ground.

If you give a node a name starting with the characters "\$G\_"; as in for example, "\$G\_VDD"; then that node is global no matter where the name occurs in the circuit hierarchy.

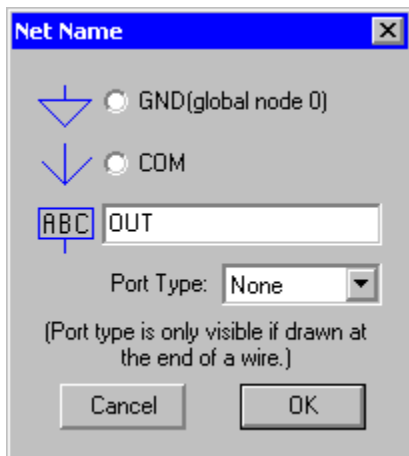

It is possible to indicate that a node is a port of type input, output, or bi-directional. These port types will be drawn differently but have no significance to the netlister. Indicating a port type can make circuit more readable. Global nodes are also drawn differently in that a box is drawn around the name.

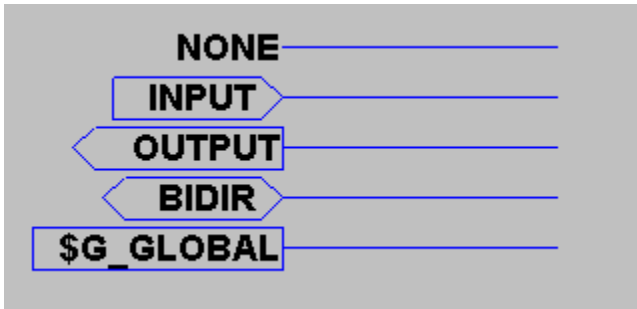

## Schematic Colors

The menu command Tools=>Color Preferences colors allows you to set the colors used in displaying the schematics. You click on an object in the sample schematic and use the red, green and blue sliders to adjust the colors to your preferences.

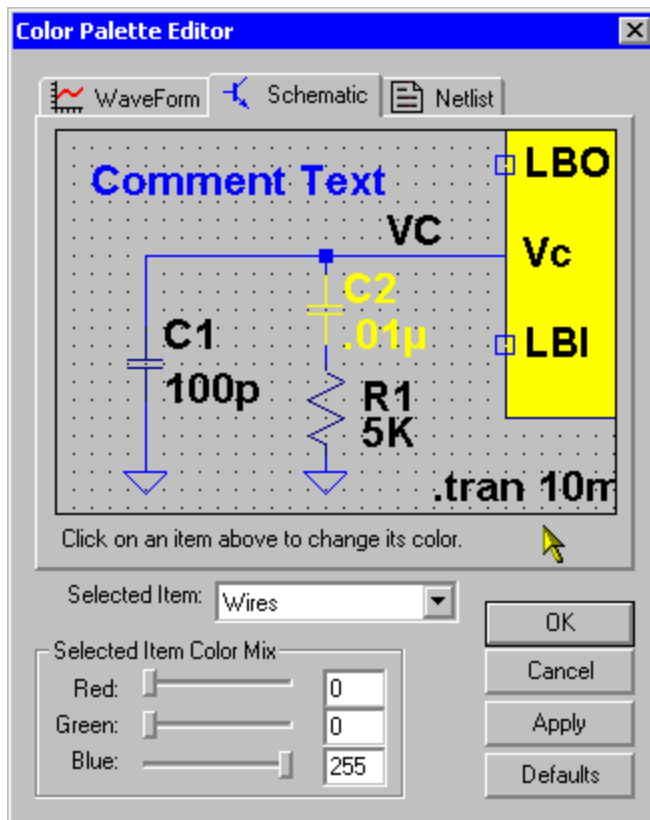

Note: Non-electrical graphical annotations made to schematics such as lines and circles will be drawn in the same color as a component body.

## Placing New Components

Certain frequently used components; such as resistors, capacitors, and inductors; can be selected for placing on the schematic with a toolbar button.

For most symbols, use the menu command Edit=>Component to start a dialog to browse for the device you wish.

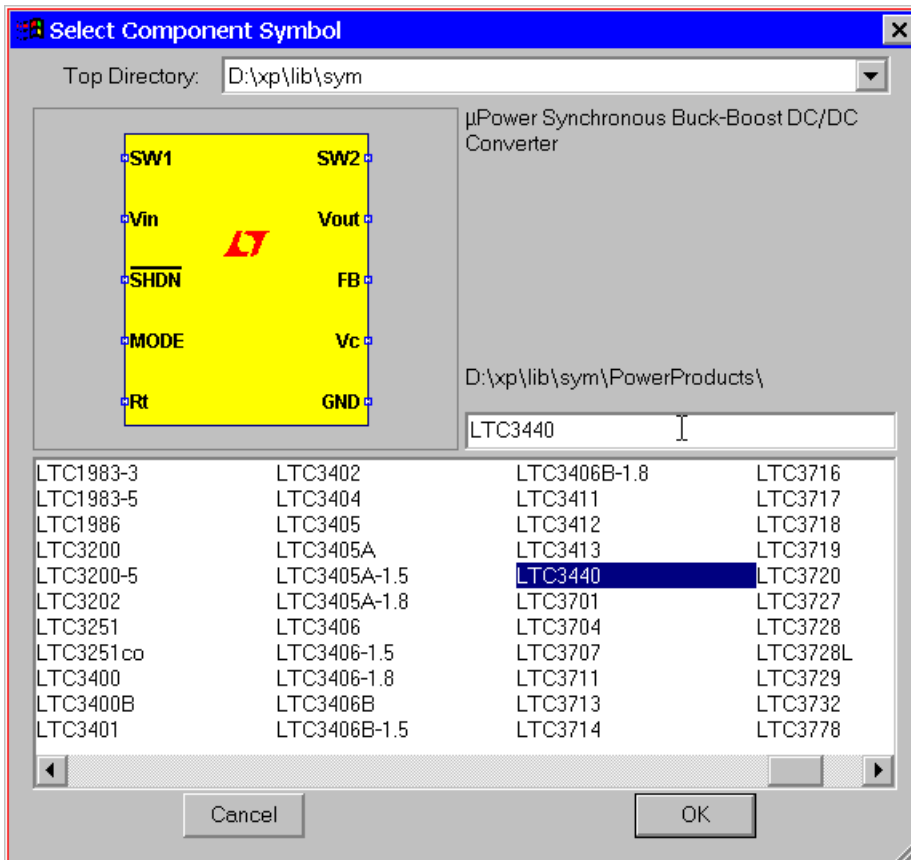

## Programming Keyboard Shortcuts

The menu command Tools=>Control Panel=>Drafting Options=>Hot Keys allows you to program the keyboard short cuts for most commands. Simply mouse click on a command and then press the key or key combination you would like to code for the command.

To remove a shortcut, click on the command and press the "Delete" key.

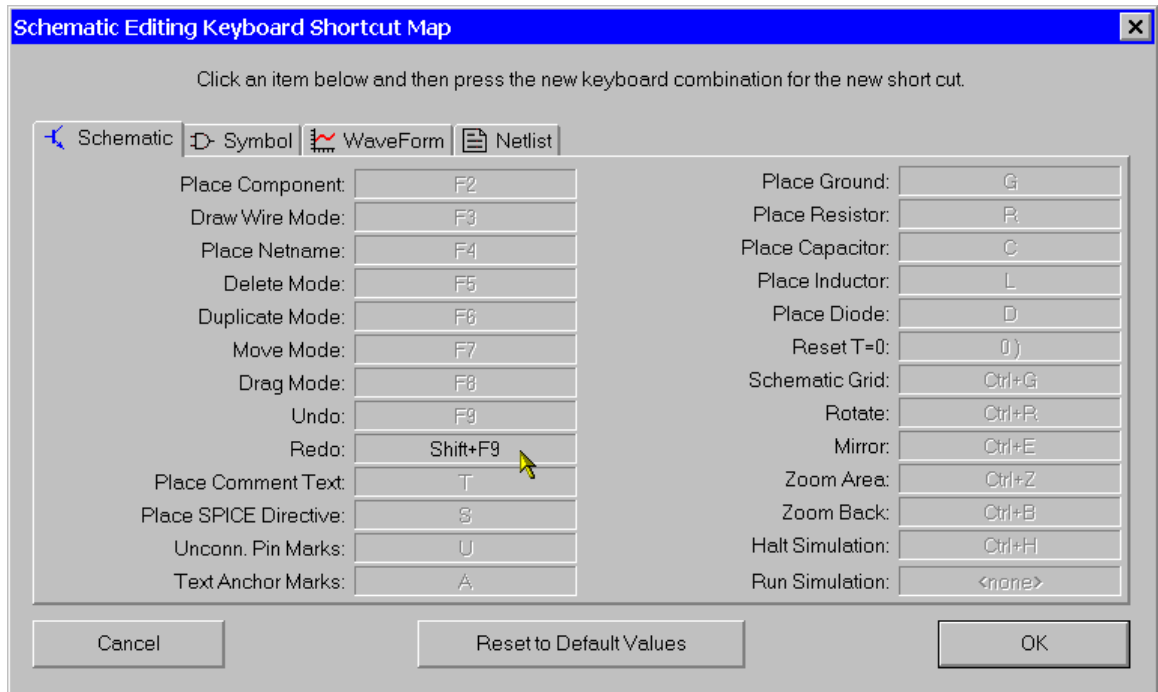

## PCB Netlist Extraction

The schematic menu command Tools=>Export Netlist allows you to generate the ASCII netlist for PCB layout. Note that you would have to make a set of symbols that have the same order of pin netlist order. For example, if you want to import an LTspice schematic's netlist into ExpressPCB you would have to make a set of symbols for either LTspice or ExpressPCB that had the same netlist order for every symbol you use. Otherwise diodes could netlist backwards or transistor lead connections could be scrambled.

The following formats are available: Accel, Algorex, Allegro, Applicon Bravo, Applicon Leap, Cadnetix, Calay, Calay90, CBDS, Computervision, EE Designer, ExpressPCB, Intergraph, Mentor, Multiwire, PADS, Scicards, Tango, Telesis, Vectron, and Wire List.

# Editing Components

## Editing Components

Components can be edited in two or three different ways, depending on the type of component:

1. Most visible component attribute fields can be edited by pointing at it with the mouse and then right clicking. The mouse cursor will turn into a text caret when it's pointing at the text.
2. Many component types, such as resistors, capacitors, inductors, diodes, bipolar transistors, MOSFET transistors, JFET transistors, independent voltage sources, independent current sources, and hierarchical circuit blocks have special editors. These editors can access the appropriate database of devices. To use these editors, right mouse click on the body of the component.
3. Place the mouse over a symbol, hold down the control key, and click the right mouse button. A dialog box will appear that displays all available symbol attributes. Next to each field is a check box to indicate if the field should be visible on the schematic.

## Edit a Visible Attribute

Most visible component attribute fields can be edited by pointing at it with the mouse and then right clicking. The mouse cursor will turn into a text caret when it's pointing at the text. This is a convenient way of changing the value of a component.

|

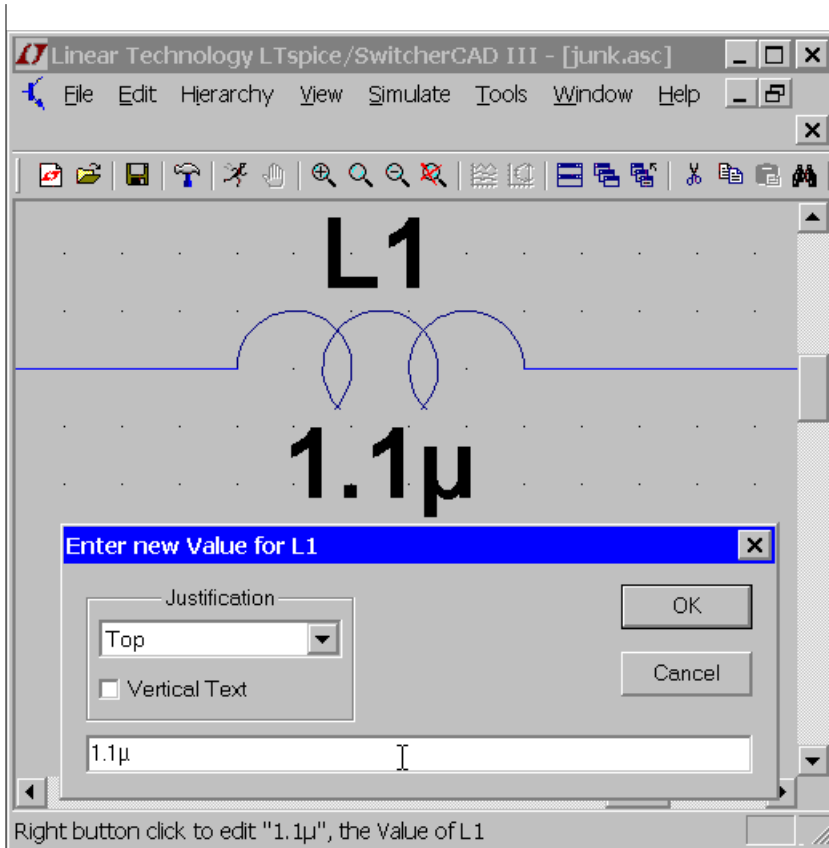

## Specialized Component Editors

Many component types, such as resistors, capacitors, inductors, diodes, bipolar transistors, MOSFET transistors, JFET transistors, independent voltage sources, independent current sources, and hierarchical circuit blocks have special editors. These editors can access the appropriate database of related components. To use these editors, right mouse click on the body of the component.

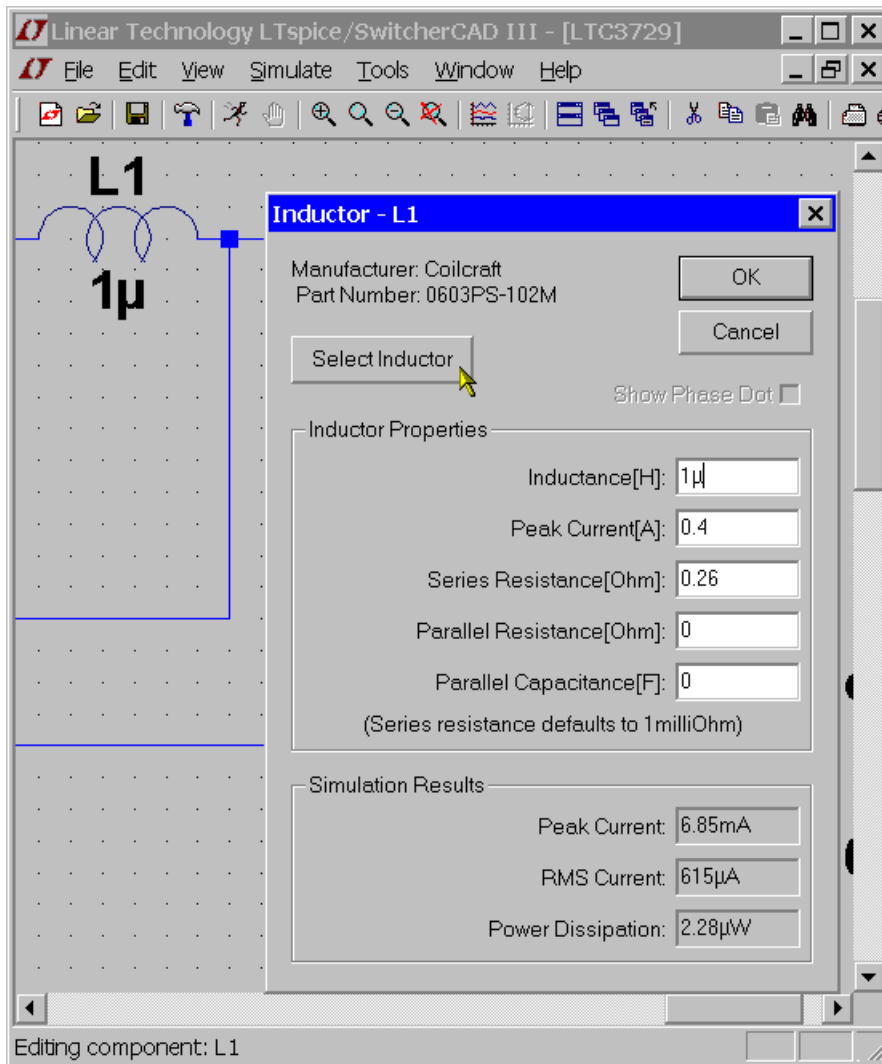

## General Attribute Editor

Sometimes it is desired to get direct access to every available component attribute to edit their contents and visibility. An editor that allows you to do this can be reached by placing the mouse over the body of a symbol, holding down the control key, and clicking the right mouse button. A dialog box will appear that displays all available symbol attributes. Next to each field is a check box to indicate if the field should be visible on the schematic.



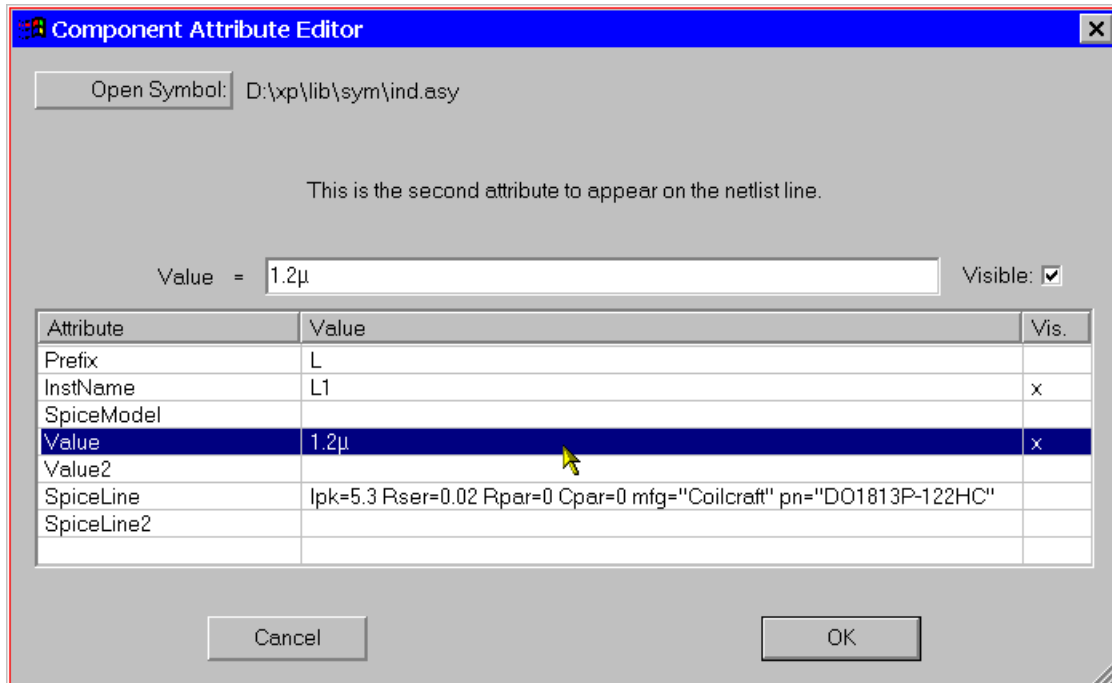

The attributes SpiceModel, Value, Value2, SpiceLine, and SpiceLine2 are all part of the overall value of the component. In terms of the way the component is netlisted for SPICE, the component will generate a line of SPICE that looks like this:

```
<name> node1 node2 [...] <SpiceModel>
+   <Value> <Value2> <SpiceLine> <SpiceLine2>
```

The prefix attribute character is prefixed to the reference designator if different than the first character of the reference designator. The Prefix character and InstName will be separated with a '\$' character in this case. For example, if you have a Prefix attribute of "M" and an InstName attribute of "Q1", the name in the netlist will be M\$Q1. This allows you use reference designators with a leading character different than SPICE uses to identify the type of device.

There are three exceptions to the above rule. There is one special symbol, jumper, that does not translate into a circuit element, but is a directive to the netlist generator that there are two different names for the same electrically identical

node. Another exception is a symbol defined to have a prefix of 'X' and both a Value and Value2 attributes defined. Such a component netlists as two lines of SPICE:

```
.lib <SpiceModel>  
<name> node1 node2 [...] <Value2>
```

This allows symbols to be defined that automatically include the library that contains the definition of the subcircuit called by the component. The netlist compiler removes duplicate .lib statements. Note that such components are not editable on the schematic. The third exception is a symbol that has other exception is a symbol defined to have a prefix of 'X' and a ModelFile attribute defined. Such a component also netlists as two lines of SPICE:

```
.lib <ModelFile>  
<name> node1 node2 [...] <SpiceModel> <Value> <Value2>  
<SpiceLine> <SpiceLine2>
```

Use this method when you want to automatically include a library file yet still want to have an instance of this symbol editable. If the symbol attribute SpiceModel exists and is the name of a subcircuit in the file specified as <ModelFile> then a drop list of all subcircuits names will be available when an instance of the symbol is edited on a schematic.

## Creating New Symbols

### Symbol Editing Overview

Symbols can represent a primitive device such as a resistor or a capacitor; a subcircuit libreried in a separate file; or another page of the schematic. This section describes how to define your own new symbols. To start a new symbol, use the menu command File=>New Symbol.

NOTE: Screen updates during symbol editing can be slow. If this is a problem with your video card, reduce the area of the symbol-editing window to speed up screen redraws and/or reduce the screen's color resolution. This will give better tactical response to mouse movement.

## Drawing the body

You draw the body of the symbol as a series of lines, rectangles, circles, and arcs. The objects have no electrical impact on the circuit. You can also draw text on the symbol with the Draw=>Text command that has no impact on the circuit. The anchor points of these objects are drawn with small red circles so you know what to grab when dragging them about. You can toggle the red markers off and on with the menu command View=>Mark Object Anchors

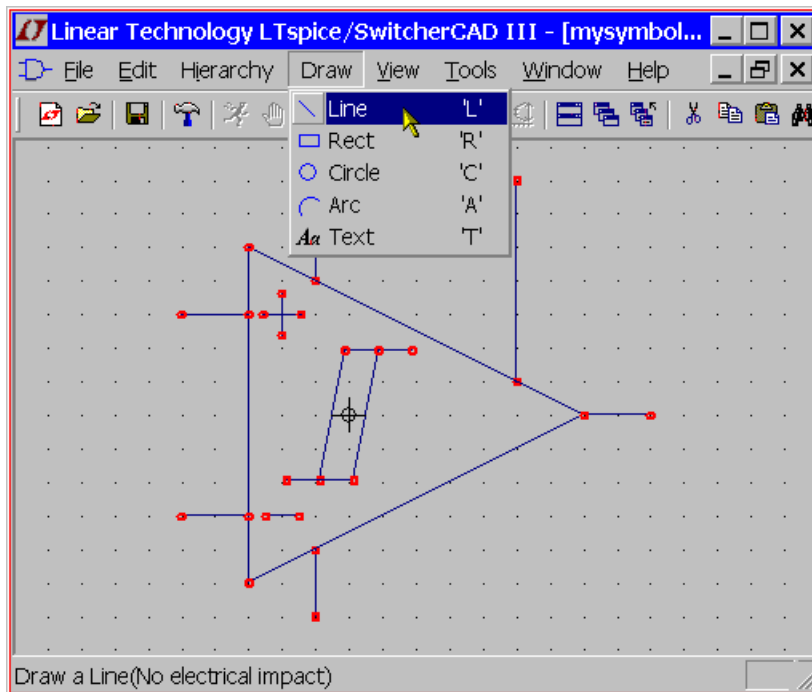

## Adding the Pins

The pins allow electrical connection to the symbol. Use the menu command Edit=>Add Pin/Port to add a new pin.

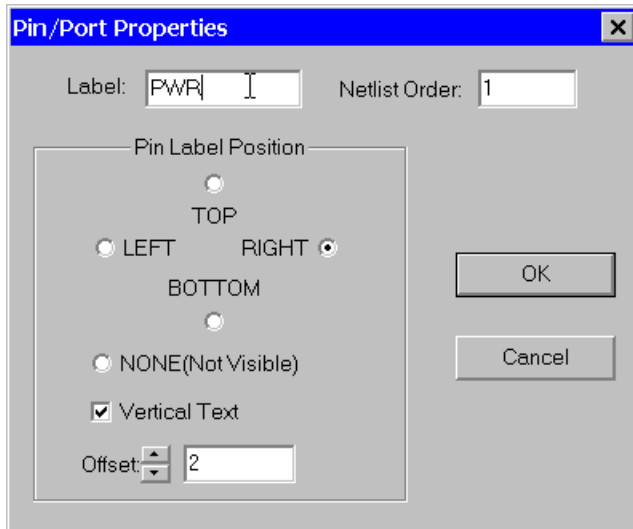

The "Pin Label Position" determines how the pin label is presented. "TOP", "BOTTOM", "LEFT", and "RIGHT" are text justifications. For example, if a pin label is TOP justified, the pin(the label's text justification's anchor point) will be above the label. If the symbol represents a SPICE primitive element or a subcircuit from a library, then the pin label has no direct electrical impact on the circuit. However, if the symbol represents lower-level schematic of a hierarchical schematic, then the pin name is significant as the name of a net in the lower level schematic.

The "Netlist Order" determines the order this pin is netlisted for SPICE.

## Adding Attributes

You can define default attributes for a symbol using the menu command Edit=>Attributes=>Edit Attributes. The most important attribute is called the "Prefix". This determines the basic type of symbol. If the symbol is intended to represent a SPICE primitive, the symbol should have the appropriate prefix, R for resistor, C or capacitor, M for MOSFET, etc. See the LTspice reference for a complete set of SPICE primitives available. The

prefix should be 'X' if you want to use the symbol to represent a subcircuit defined in a library.

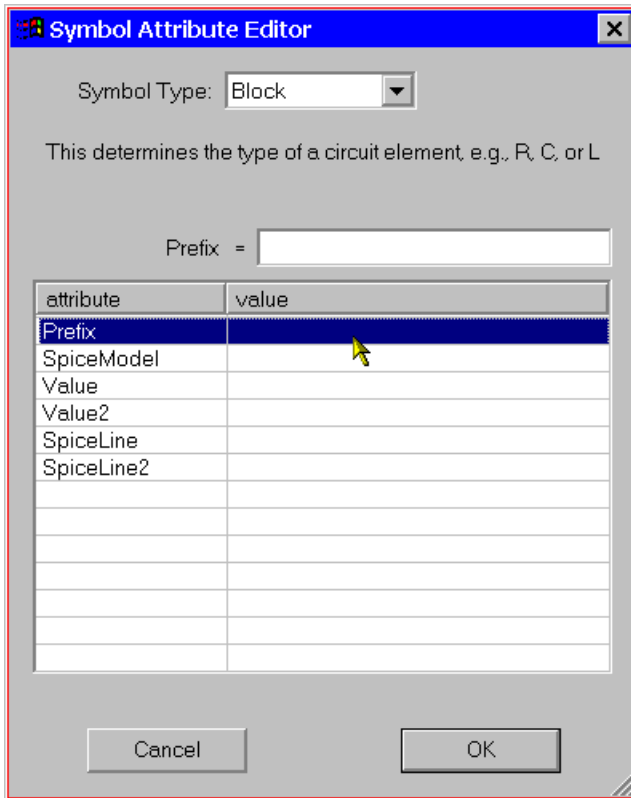

The symbol's attributes can be overridden in the instance of the symbol as a component in a schematic. For example, if you have a symbol for a MOSFET with a prefix attribute of 'M', it's possible to override the prefix to an 'X' on an instance-by-instance basis so that the transistor can be modeled as subcircuit instead.

There is a special combination of attributes that will cause a required library to be automatically included in every schematic that uses the symbol:

Prefix: X

SpiceModel: <name of file including the spicemodel>

Value: <What ever you want visible on the schematic>

Value2: <The value as you want in the netlist>

Value2 would be made to coincide with a subcircuit name defined in the file including the spicemodel and may pass additional parameters to the subcircuit. When a symbol is defined in this manner, an instance of the symbol as a component on a schematic cannot be edited to have different attributes.

If you wish the symbol to represent another page of a hierarchical schematic, all attributes should be left blank the symbol type should be changed from "Cell" to "Block". No attribute values need be set.

There is a symbol attribute, ModelFile, that may be specified. This is used for the name of a file to be included in the netlist as a library. If the prefix attribute is 'X' and there is a symbol attribute SpiceModel defined that is subcircuit defined in the model file, then a drop list of all subcircuits names will be available when an instance of the symbol is edited on a schematic.

## Attribute Visibility

You can edit the visibility of attributes using the menu command Edit=>Attributes=>Attribute Window. After you select an attribute with this dialog you will then be able to position it as you wish with respect to the symbol.

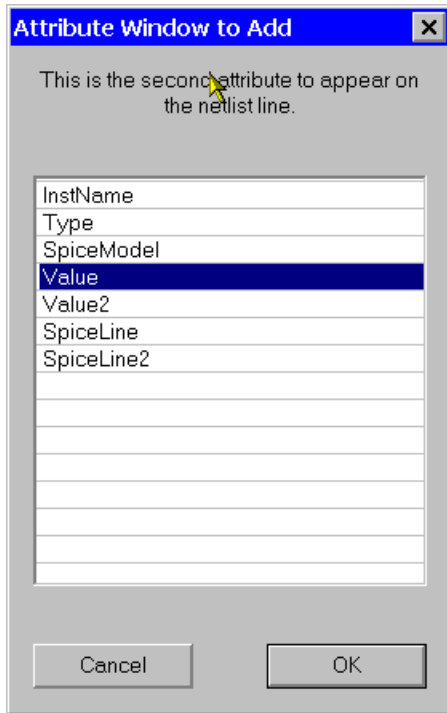

You can modify the text justification and contents of attributes that you've already made visible by right mouse clicking on the text of the attribute.

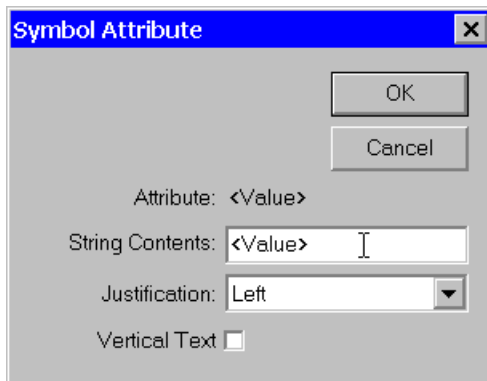

## Automatic Symbol Generation

A symbol can be automatically generated in two situations.

When editing a schematic, you can execute menu item Hierarchy=>Open this Sheet's Symbol. When no symbol is found, LTspice will ask if you would like one automatically generated. This symbol then can be used to call this sheet of circuitry is some higher level schematic.

Also, when editing an ASCII netlist that contains subcircuit definitions, you place the cursor on the line containing the name of the subcircuit, right click, and execute context menu item "Create Symbol"

## Hierarchy

### Hierarchy Overview

Hierarchical schematic drafting has powerful advantages. Much larger circuits can be drafted than can fit onto a one sheet schematic while retaining the clarity of the smaller schematics. Repeated circuitry to be easily handled in an abstract manner. Blocks of circuitry can be libreried for latter use in a different project.

### Rules of Hierarchy

The way to refer to another schematic as a block in a higher level schematic is to create a symbol with the same name as the block schematic and then by placing that symbol on the higher level schematic. For example, if you have a top-level schematic called topXYZ.asc and another schematic file called preamp.asc that you wish to place in the schematic of topXYZ then create a symbol called preamp.asy and place an instance of that symbol on the schematic of topXYZ. The electrical connectivity between the schematics is established by connecting wires of the higher-level schematic to pins on the lower level block's symbol that matches the name of a node in the lower-level schematic. As the names of symbols used as schematic blocks and the names of the schematics corresponding to those block must consist of valid characters that can be used as filenames. They also cannot contain the space character.



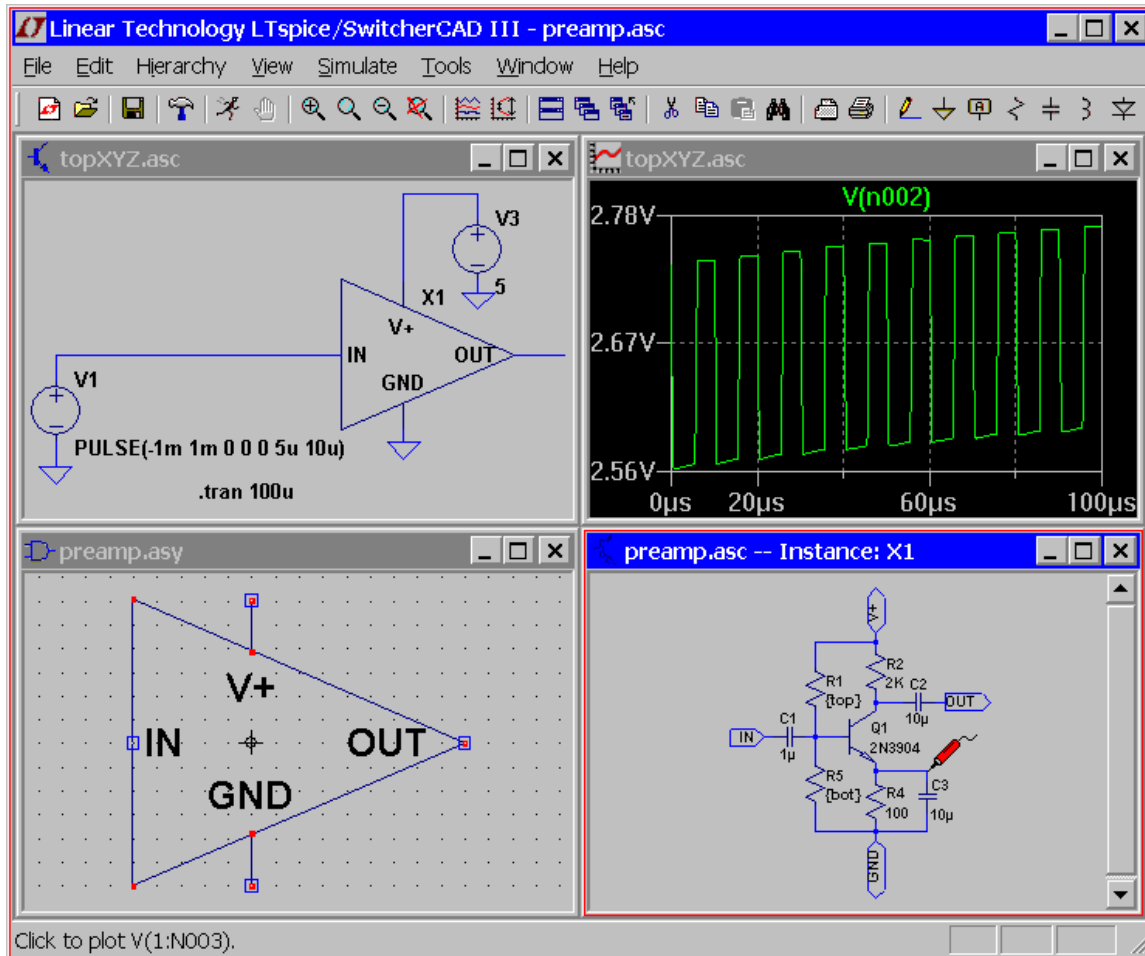

LTspice will look in the directory of the top-level schematic for symbols and blocks to complete the circuitry of the top-level schematic.

The symbol you create to represent the lower-level schematic block should have no attributes defined.

## Navigating the Hierarchy

Any file opened with the File=>Open command is considered a top-level schematic. You can add SPICE directives to that block and run simulations using only it and any lower-level schematics to which it refers.

To open a schematic block as an instance of a block of a higher-level schematic, first open the higher-level schematic and then move the mouse to the body of the instance of the symbol calling the block. When you right mouse click on the body of the instance of that symbol, a special dialog appears that allows you to open the schematic. When you open the schematic in this manner, you can cross probe the nodes and current in the block. Note that you should have the options "Save Subcircuit Node Voltages" and "Save Subcircuit Device Currents" checked on the Save Defaults Pane of the Control Panel. Also, if you've highlighted a node on the top-level schematic, that node will be also highlighted in the lower level block.

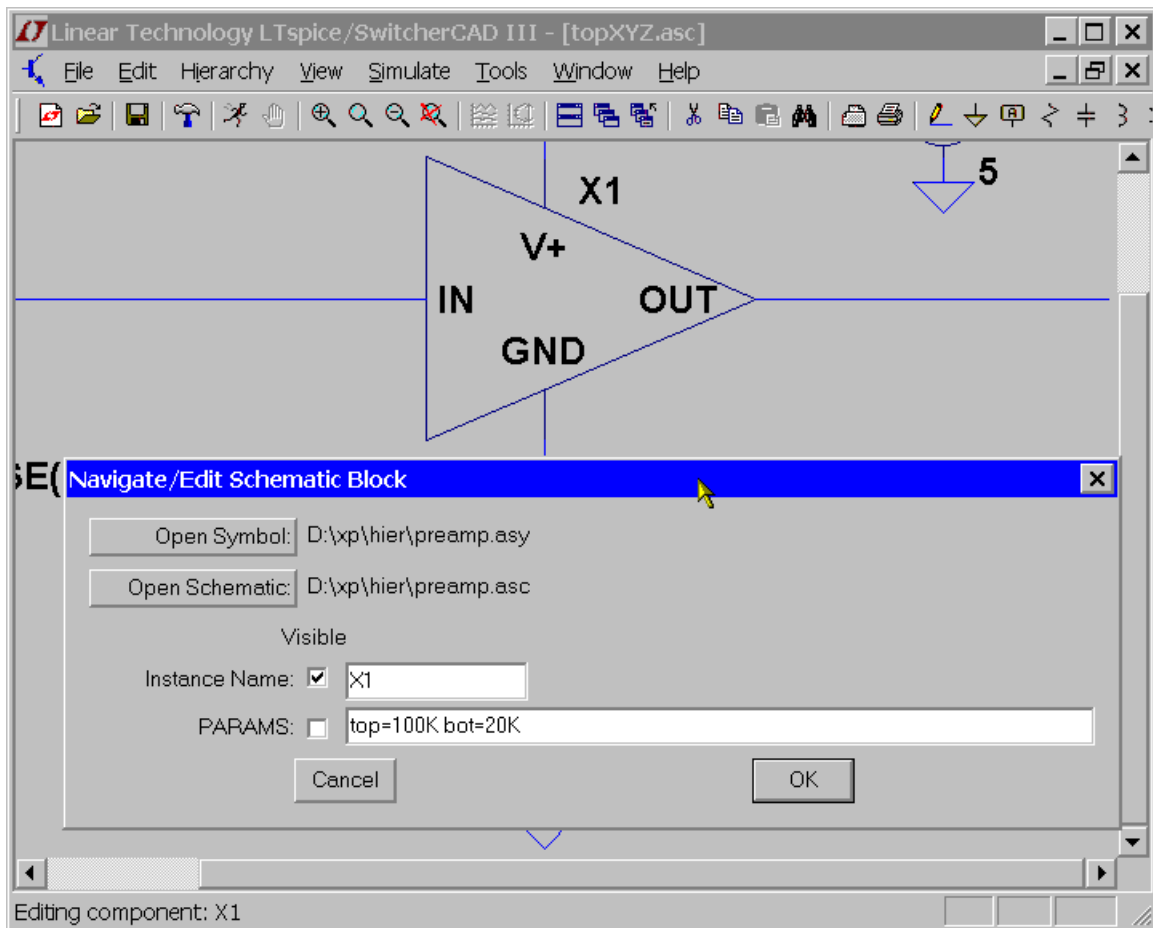

Note that is dialog also allows you to enter parameters to pass to this instance of the circuitry in preamp.asc.

# Waveform Viewer

## Waveform Viewer Overview

LTspice IV includes an integrated waveform viewer that allows complete control over the manner the simulation data is plotted.

## Data Trace Selection

There are three basic means of selecting plotted traces.

1. Probing directly from the schematic
2. Menu command Plot Settings=>Visible Traces
3. Menu command Plot Settings=>Add Trace

The undo and redo commands allow you to review the different trace selections plotted no matter which method of selection is used.

1. Probing directly from the schematic:

The easiest method is to simply probe the schematic. You simply point and click at a wire to plot the voltage on that wire. You plot the current through any component with two connections (like a resistor, capacitor or an inductor) by clicking on the body of the component. This works at any level of the circuit's hierarchy. You can also plot current into a particular connection of a component with more than two pins by clicking on that pin of the symbol. If you click the same voltage or current twice, then all other traces will be erased and the double clicked trace will be plotted by itself. You can delete individual traces by clicking on the trace's label after selecting the delete command. The following screen shot shows how to point at a pin current. Notice that the mouse cursor turns into an icon that looks like a clamp on ammeter when it's pointing at a current that can be plotted.

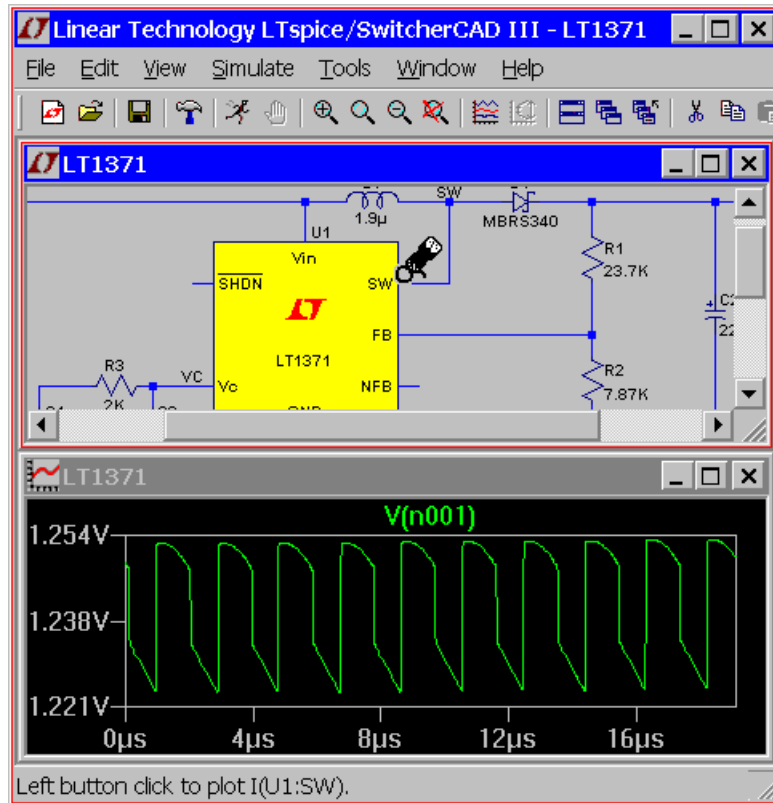

When plotting a pin current, the convention of positive current is in the direction into the pin.

It is also possible to point at voltage differences with the mouse. You can click on one node and drag the mouse to another node. You will see the red voltage probe at the first node and a black probe on the second. This allows you to differentially plot voltages:

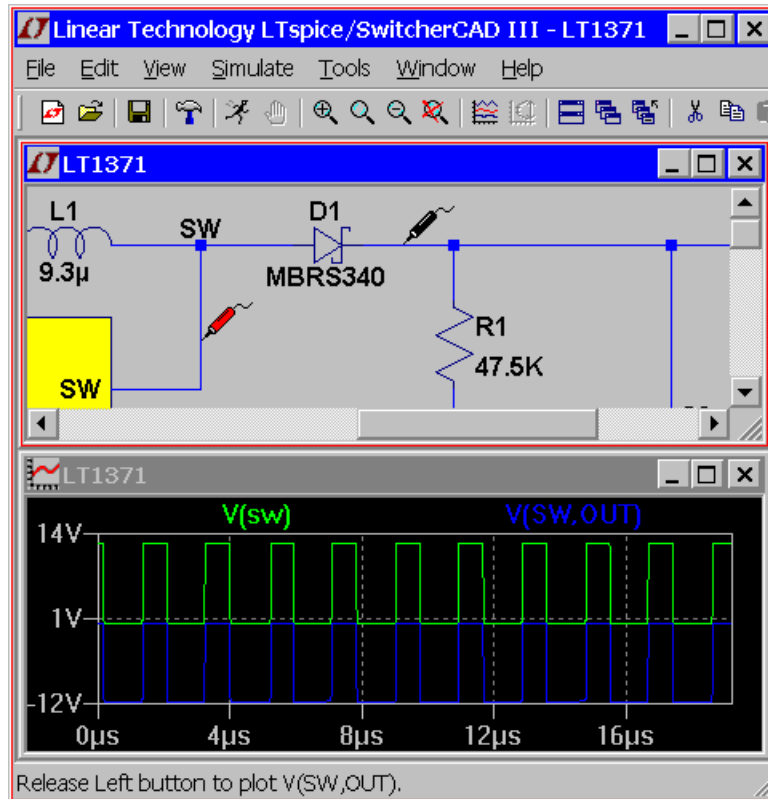

Yet another schematic probing technique is to plot the instantaneous power dissipation of a component. To do this, hold down the Alt key and click on the body of the symbol of the component. The instantaneous power dissipation will be plotted as an expression of voltages and currents. It will be plotted on its own scale with the units of Watts. The mouse cursor turns into an icon that looks like a thermometer when it's pointing at a dissipation that can be plotted. You can find the average power dissipation by control-clicking the trace label.

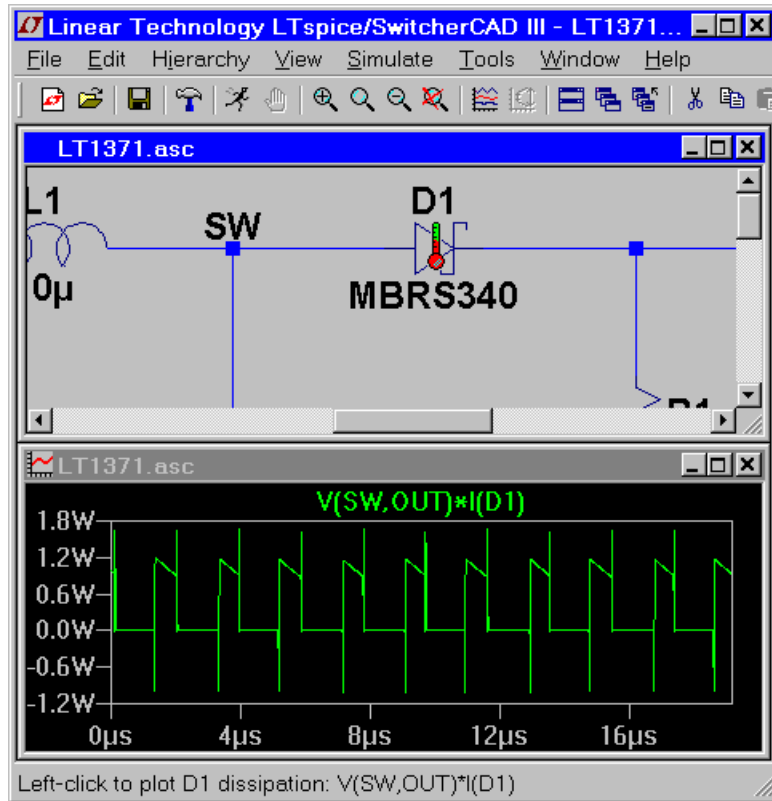

## 2. Menu command Plot Settings=>Visible Traces:

The menu command Plot Settings=>Visible Traces is the dialog seen at the beginning of plotting data from a simulation. It lets you select the initial traces to start the plot. It also gives you random access to the full list of traces plotted.

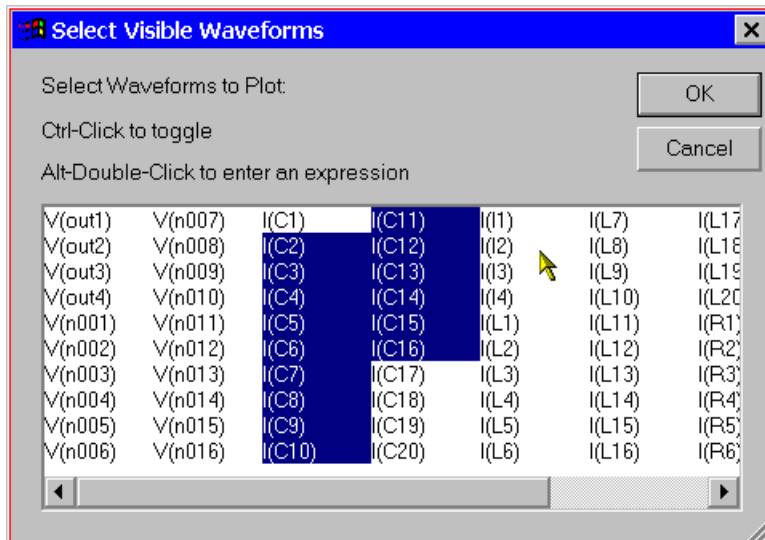

### 3. Menu command View=>Add Trace:

The Plot Settings=>Add Trace command is similar to the Plot Settings=>Visible Traces command. However, you can not delete traces that are already visible with it. It has two useful capabilities. One is an edit box near the top of the dialog that allows you to enter a pattern of characters. Only trace names that match the pattern will be shown in the dialog. This is very useful for finding a trace when you can only partially remember the name. Also, it's a bit easier to compose an expression of trace data because you can click on a name in the dialog instead of typing out its name.

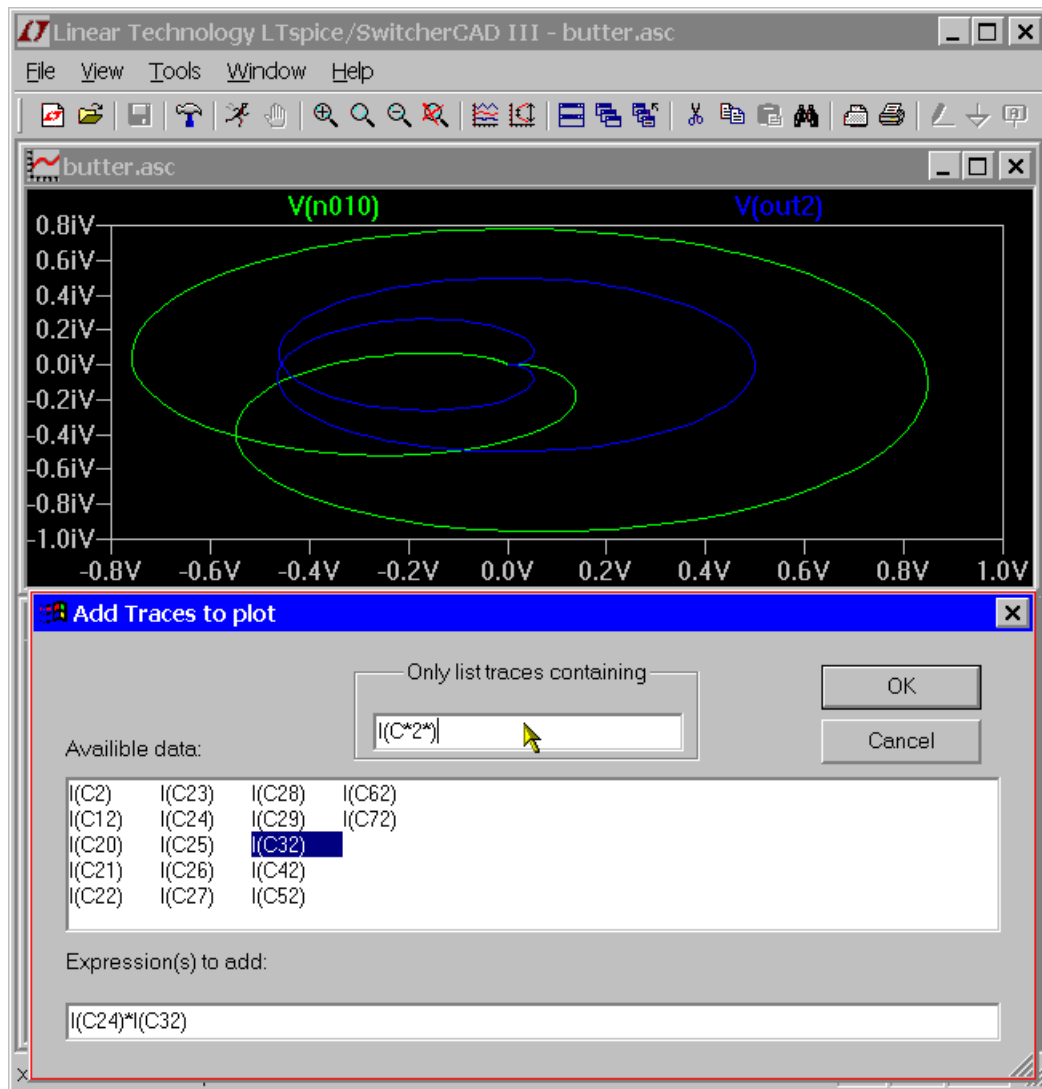

# Zooming

LTspice IV autozooms whenever there is new data to plot. To zoom up on an area, simply drag a box about the region you wish to see drawn larger.

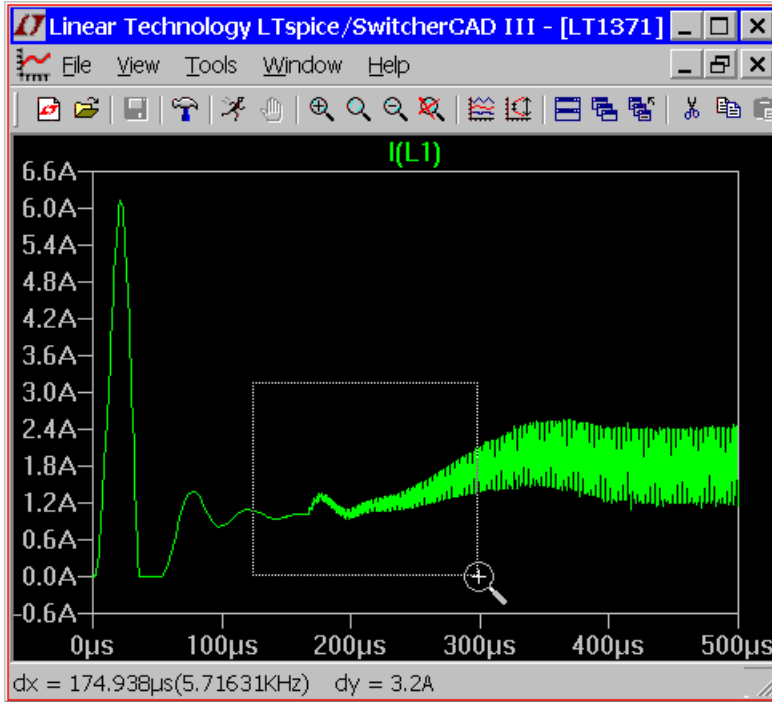

There are toolbar buttons and menu commands for zooming out, panning, and returning to the autoranged zoom. Note the undo and redo commands allow you to review the different zooms used.

# Waveform Arithmetic

There are three types of mathematical operations that can be performed on waveform data:

1. Plot expressions of traces.
2. Compute the average or RMS of a trace.
3. Display the Fourier Transform of a Trace.



## 1. Plot expressions of traces.

Both the View=>Visible Traces and View=>Add Trace commands allow one to enter an expression of data. Another method to plot an expression of available simulation data traces is to move the mouse to the trace's label and right click. This dialog box also allows you to set the trace's color and allows you to attach a cursor to the waveform. LTspice will do a dimensional analysis of the expression and plot it against a vertical axis labeled with those units. All waveforms in a plotting pane with the same units are plotted on the same axis.

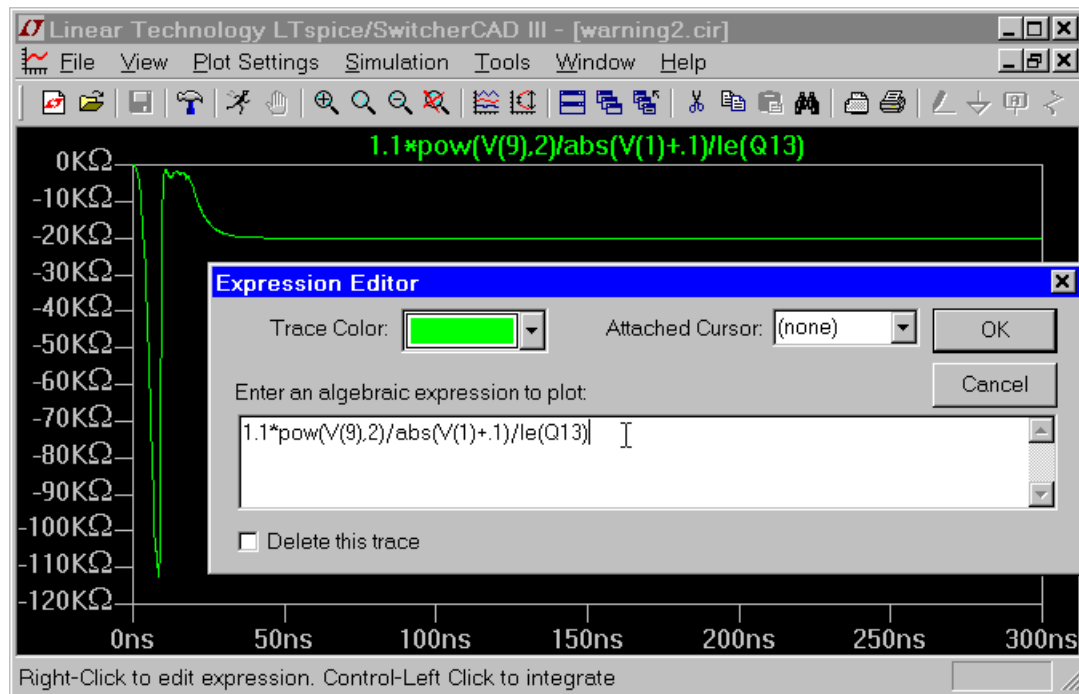

The difference of two voltages; e.g.,  $V(a) - V(b)$ ; can equivalently be written as  $V(a,b)$ . The following functions are available for real data:

Function Name	Description
$\text{abs}(x)$	Absolute value of $x$
$\text{acos}(x)$	Arc cosine of $x$

<code>arccos(x)</code>	Synonym for <code>acos()</code>
<code>acosh(x)</code>	Arc hyperbolic cosine
<code>asin(x)</code>	Arc sine
<code>arcsin(x)</code>	Synonym for <code>sin()</code>
<code>asinh(x)</code>	Arc hyperbolic sine
<code>atan(x)</code>	Arc tangent of x
<code>arctan(x)</code>	Synonym for <code>atan()</code>
<code>atan2(y, x)</code>	Four quadrant arc tangent of y/x
<code>atanh(x)</code>	Arc hyperbolic tangent
<code>buf(x)</code>	1 if $x > .5$ , else 0
<code>ceil(x)</code>	Integer equal or greater than x
<code>cos(x)</code>	Cosine of x
<code>cosh(x)</code>	Hyperbolic cosine of x
<code>d()</code>	Finite difference-based derivative
<code>exp(x)</code>	e to the x
<code>floor(x)</code>	Integer equal to or less than x
<code>hypot(x,y)</code>	$\sqrt{x^2 + y^2}$
<code>if(x,y,z)</code>	If $x > .5$ , then y else z
<code>int(x)</code>	Convert x to integer
<code>inv(x)</code>	0. if $x > .5$ , else 1.
<code>limit(x,y,z)</code>	Intermediate value of x, y, and z
<code>ln(x)</code>	Natural logarithm of x
<code>log(x)</code>	Alternate syntax for <code>ln()</code>
<code>log10(x)</code>	Base 10 logarithm
<code>max(x,y)</code>	The greater of x or y
<code>min(x,y)</code>	The smaller of x or y

<code>pow(x,y)</code>	<code>x**y</code>
<code>pwr(x,y)</code>	<code>abs(x)**y</code>
<code>pwrsgn(x,y)</code>	<code>sgn(x)*abs(x)**y</code>
<code>rand(x)</code>	Random number between 0 and 1 depending on the integer value of x.
<code>random(x)</code>	Similar to <code>rand()</code> , but smoothly transitions between values.
<code>round(x)</code>	Nearest integer to x
<code>sgn(x)</code>	Sign of x
<code>sin(x)</code>	Sine of x
<code>sinh(x)</code>	Hyperbolic sine of x
<code>sqrt(x)</code>	Square root of x
<code>table(x,a,b,c,d, ...)</code>	Interpolate a value for x based on a look up table given as a set of pairs of points.
<code>tan(x)</code>	Tangent of x.
<code>tanh(x)</code>	Hyperbolic tangent of x
<code>u(x)</code>	Unit step, i.e., 1 if $x > 0.$ , else 0.
<code>uramp(x)</code>	x if $x > 0.$ , else 0.
<code>white(x)</code>	Random number between $-.5$ and $.5$ smoothly transitions between values even more smoothly than <code>random()</code> .

For complex data, the functions `atan2()`, `sgn()`, `u()`, `buf()`, `inv()` `uramp()`, `int()`, `floor()`, `ceil()`, `rand()`, `min()`, `limit()`, `if(,,)`, and `table(...)` are not available. The functions `Re(x)` and `Im(x)` are available for complex data and return a complex number with the real part equal to the real or imaginary part of the argument respectively and the imaginary part equal to zero. The functions `Ph(x)` and `Mag(x)` are also available for complex data and return a complex number with the real part equal

to the phase angle or magnitude of the argument respectively and the imaginary part equal to zero. The function `conj(x)` is also available for complex data and returns the complex conjugate of `x`.

The following operations, grouped in reverse order of precedence of evaluation, are available for real data:

<b>Operator</b>	<b>Description</b>
<code>&amp;</code>	Convert the expressions to either side to Boolean, then AND.
<code> </code>	Convert the expressions to either side to Boolean, then OR.
<code>^</code>	Convert the expressions to either side to Boolean, then XOR.
<code>&gt;</code>	TRUE if expression on the left is greater than the expression on the right, otherwise FALSE.
<code>&lt;</code>	TRUE if expression on the left is less than the expression on the right, otherwise FALSE.
<code>&gt;=</code>	TRUE if expression on the left is less than or equal the expression on the right, otherwise FALSE.
<code>&lt;=</code>	TRUE if expression on the left is greater than or equal the expression on the right, otherwise FALSE.
<code>+</code>	Addition
<code>-</code>	Subtraction
<code>*</code>	Multiplication
<code>/</code>	Division

- \*\*            Raise left hand side to power of right hand side.
  
- !            Convert the following expression to Boolean and invert.
  
- @            Step selection operator

TRUE is numerically equal to 1 and FALSE is 0. Conversion to Boolean converts a value to 1 if the value is greater than 0.5, otherwise the value is converted to 0.

The step selection operator, '@' is useful when multiple simulation runs are available as in a .step, .temp, or .dc analysis. It selects the data from a specific run. For example, V(1)@3 would plot the data from the 3<sup>rd</sup> run no matter what steps were selected for plotting.

For complex data, only +, -, \*, /, \*\*, and @ are available. Also with regard to complex data, the Boolean XOR operator, ^ is understood to mean exponentiation, \*\*.

The following constants are internally defined:

Name	Value
E	2.7182818284590452354
Pi	3.14159265358979323846
K	1.3806503e-23
Q	1.602176462e-19

The keyword "time" is understood when plotting transient analysis waveform data. Similarly, "freq" and "omega" are understood when plotting data from an AC analysis. "w" can be used as a synonym for omega.

2. Compute the average or RMS of a trace.

The waveform viewer can integrate a trace to obtain the average and RMS value over the displayed region. First zoom the waveform to the region of interest, then move the mouse to the label of the trace, hold down the control key and left mouse click.

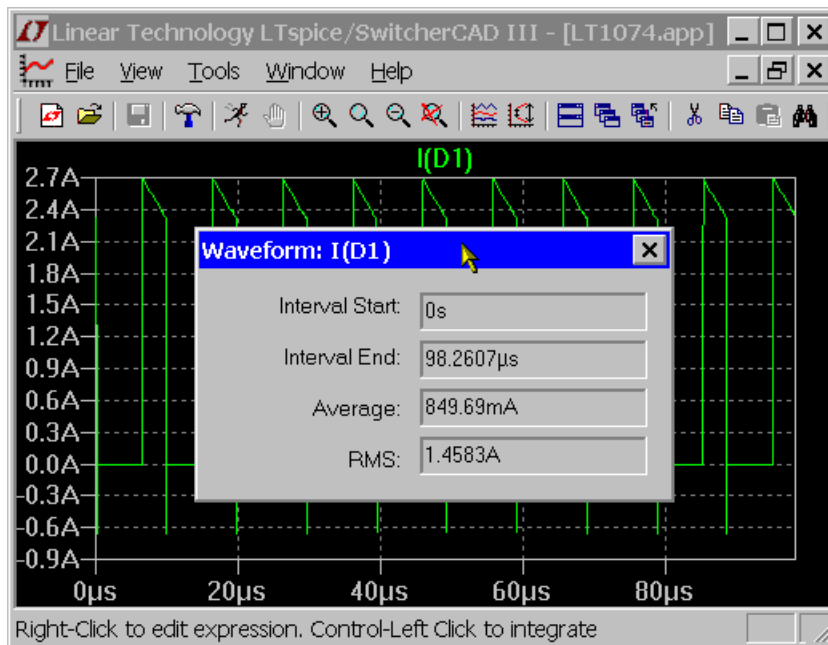

3. Display the Fourier Transform of a Trace.

You can use the menu command View=>FFT to perform a Fast Fourier transform on various data traces.

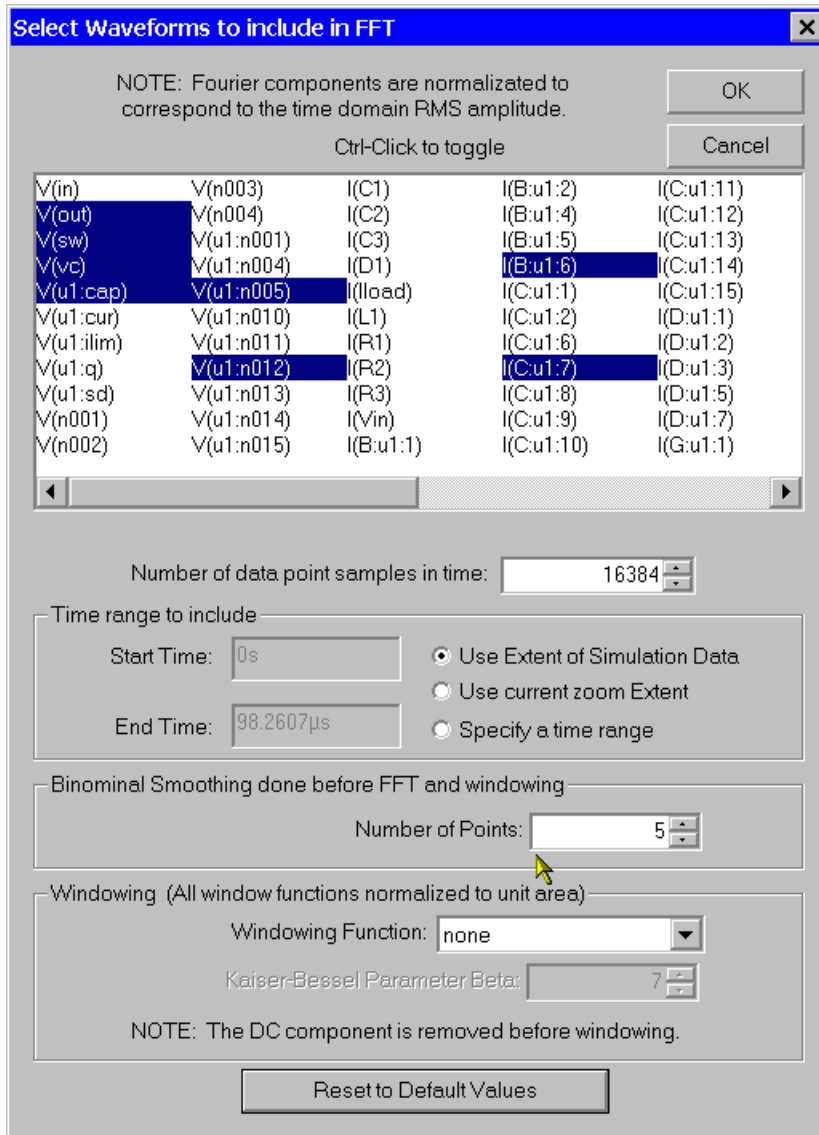

## User-Defined Functions

The menu command Plot Settings=>Edit Plot Defs File allows you to enter your own function definitions and parameter definitions for use in the waveform viewer. These functions are kept in the file plot.defs in the same directory as the LTspiceIV executable, scad3.exe.

Then the syntax is the same as the .param and .func statements used for parameterized circuits. E.g., the line

```
.func Pythag(x,y) {sqrt(x*x+y*y)}
```

defines the function `Pythag()` to be the square root of the sum of its two arguments.

Similarly, the line

```
.param twopi = 2*pi
```

would define `twopi` to be 6.28318530717959. Note that it uses the already internally defined constant `pi` of the waveform viewer.

## Axis Control

When you move the mouse cursor beyond the data plotting region, the cursor turns into a ruler. This tries to indicate that you are pointing at that axis' attributes. When you left click you can enter a dialog to manually enter that axis' range and the nature of the plot. For example, for real data, if you move the mouse to the bottom of the screen and left click, you can enter a dialog to change the horizontal quantity plotted. This lets you make parametric plots.

For complex data, you can choose to plot either phase, group delay, or nothing against the right vertical axis. You can change the representation of complex data from Bode to Nyquist or Cartesian by moving the mouse to the left vertical axis of complex data.

## Plot Panes

Multiple plot panes can be displayed on one window. This allows better separation between traces and allows different traces to be independently autoscaled. Traces can be dragged between panes by dragging the label. A copy of a trace can be made on another pane by holding down the control key when you release the mouse button.



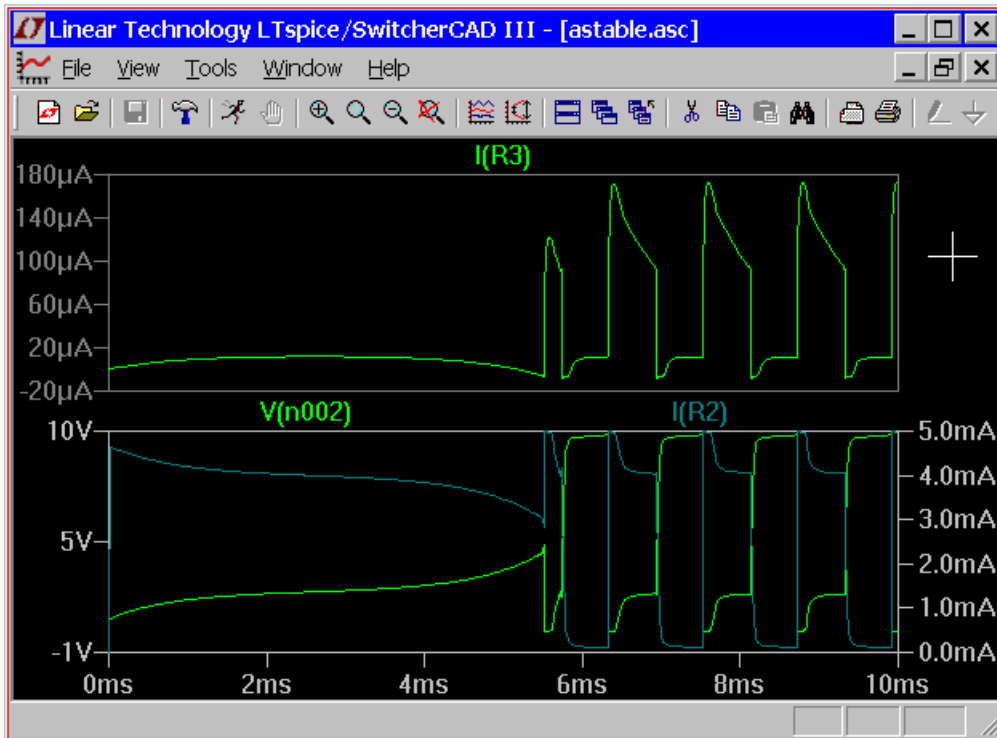

## Color Control

The menu command Tools=>Color Preferences colors allows you to set the colors used for plotting data. You click on an object in the sample plot and use the red, green and blue sliders to adjust the colors to your preferences.

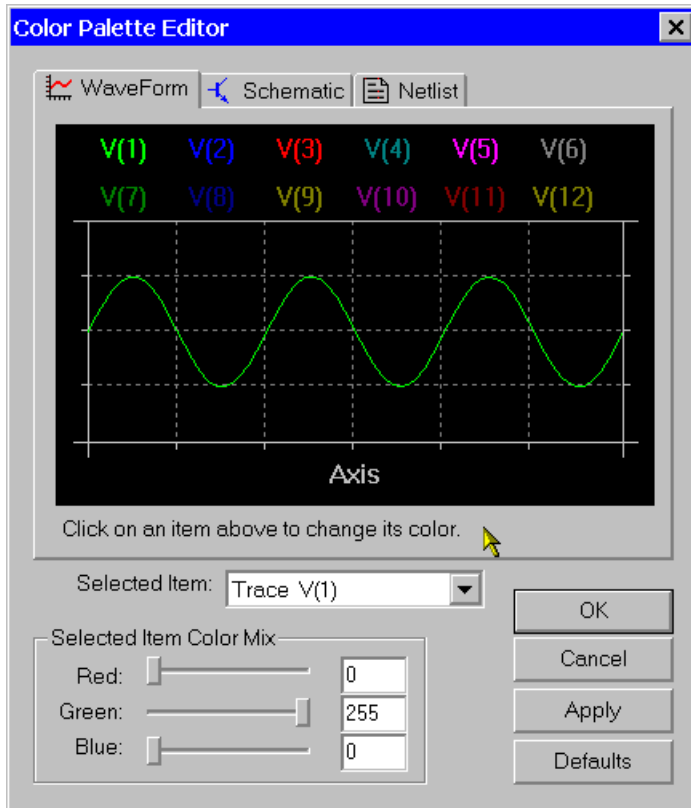

## Attached Cursors

There are up to two attached cursors available. You can attach a cursor to a trace by left mouse clicking on the trace label. You can attach both cursors to a single trace by right clicking on the trace label and selecting "1st & 2nd". You can also attach the 1st or 2nd cursor or both cursors to any trace by right clicking on that trace's label and using the Attached Cursor drop down box. The attached cursors can be dragged about with the mouse or moved with the cursor keys.

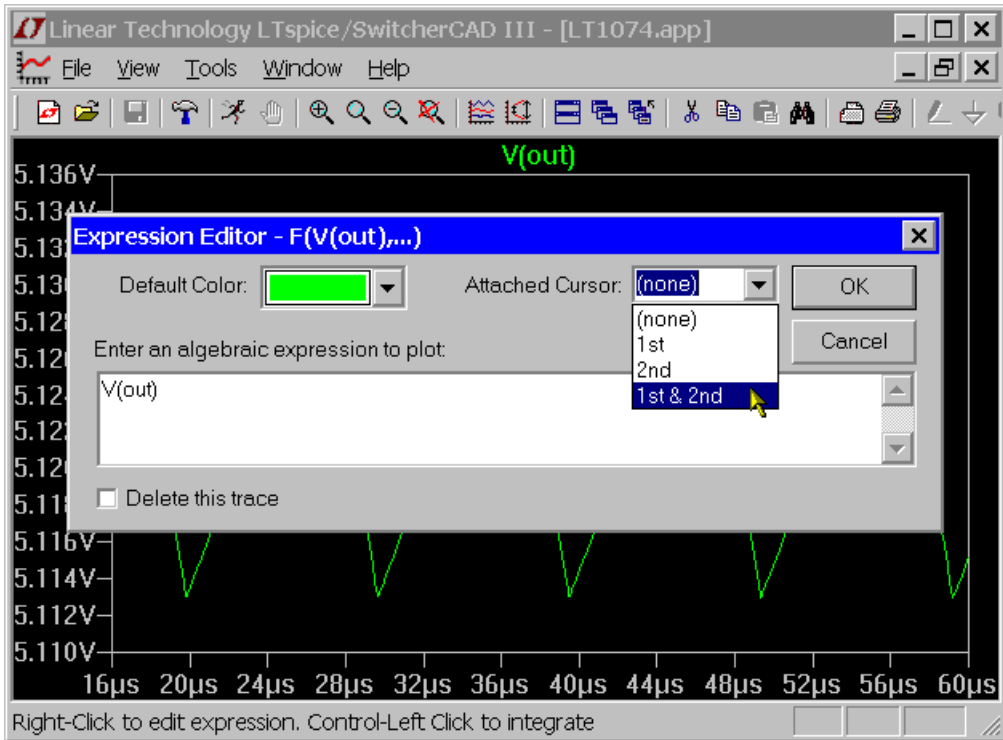

When there are attached cursors active, a readout display becomes visible that will tell you the location and difference of the cursors.

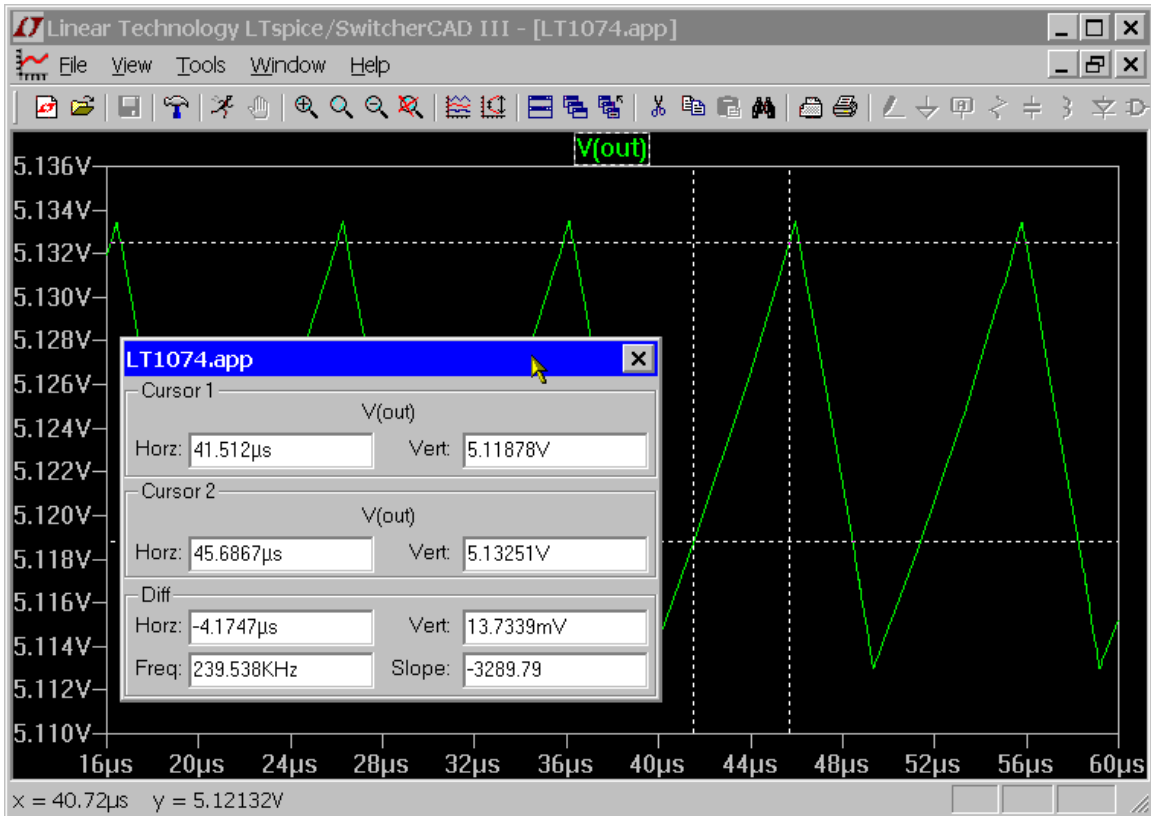

Note that there is also mouse cursor readout independent of the above attached cursor readout. As you move the mouse over the waveform window, the mouse position is readout on the status bar. If you drag the mouse as if you were going to zoom, the size of box is displayed on the status bar. This lets you quickly measure differences with the mouse cursor. If the horizontal axis is time, then this time difference is also converted to frequency.

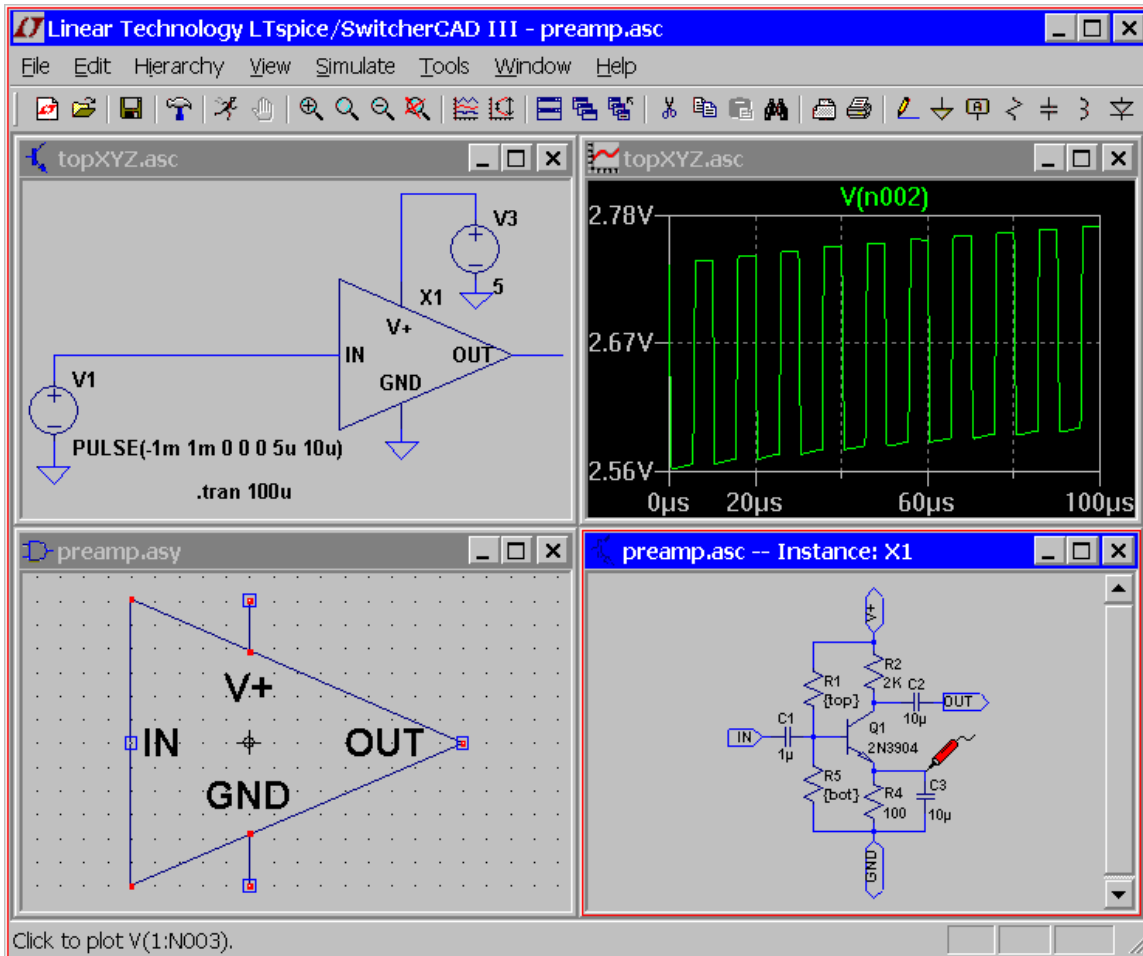

You can measure differences in this manner without performing the zoom by either pressing the Esc key or right mouse button before releasing the left mouse button.

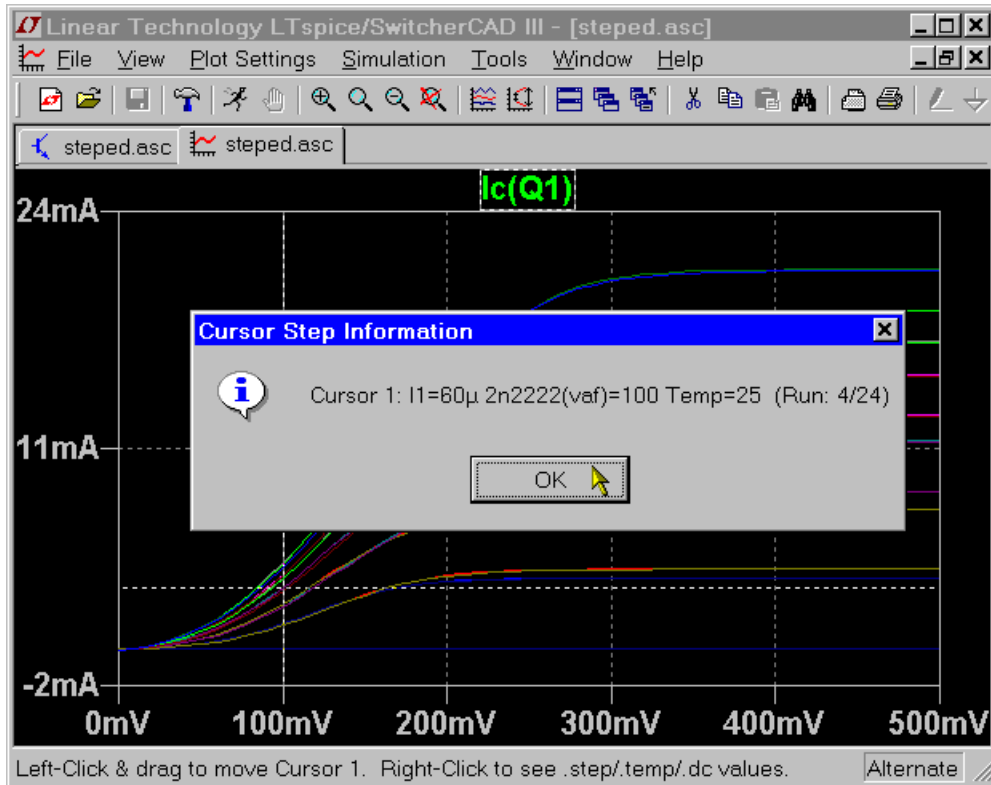

The attached cursors can also be used to readout which trace belongs to which run of a .step/.dc/.temp set of simulation runs. You can navigate the cursor from dataset to dataset with the up/down keyboard cursor keys and then right-click on the cursor to see the step information for that run.

## Save Plot Configurations

The menu commands Plot Settings=>Save Plot Settings/Open Plot Settings files allow you to read and write plot configurations to disk. Plot setting files are ASCII files that have a file extension of .plt. The default filename is computed from the name of the data file by replacing the data file's ".raw" extension with ".plt". If such a file name exists when a data file is first opened, that plot settings file is read for initial plot configuration.

Each analysis type; .tran, .ac, .noise, etc.; has its own entry in the plot settings file. It isn't possible to load the settings from one analysis type to another. But you can use the plot settings file from another simulation of the same analysis type.

## Fast Access File Format

During simulation, LTspice usually uses a compressed binary file format that allows additional simulation data to be appended without modifying the rest of the file. But once the simulation is completed, this file format can be slow to access for the purposes of adding a single new plot trace from the file.

To reduce this time, you can convert the file to an alternative, Fast Access, format. This format can only be done after the simulation is completed when no new data will be added to the file. But once the file is converted to this format, the load time of a new traces will be reduced typically by a factor equal to the number of data traces that have been saved in the file. For example, if you have a 5GB file with 2000 data traces, it might take 4min to add a new trace. But after you convert it to Fast Access format, this four minute load time would be reduced to a single second. This makes cross probing large circuits with huge simulation data files interactive. The exact time it takes to load a trace from a Fast Access format file will depend more on the amount of physical memory you have than your hard disk speed.

To convert a waveform window to Fast Access format, make the waveform window the active window and execute menu command =>Files=>Convert to Fast Access. The conversion process will require an amount of free disk space equal to the file size to be converted, but the converted file will be only 11 bytes larger than the original file.

The conversion process can take a long time and use up to one quarter of your physical memory. In fact, it can take more time to convert the file to Fast Access format than was required for the initial simulation. The exact time the conversion requires will depend on such factors as the state of the hard disk fragmentation and the amount of physical memory you have. During conversion, you may find your machine is not very responsive to your mouse and keyboard. It is possible to convert files in a batch command with the following command line syntax:

```
scad3.exe -FastAccess <file>
```

Where <file> is the name of the .raw file you wish to convert to Fast Access format.

This format is only supported for real data, not the complex data that comes from a .ac analysis.

## Memory, RAM, and Address Space

LTspice was the first PC-based SPICE program to implement its own 64bit address on the hard disk to allow one to view waveform data files of essentially unlimited file size. LTspice can address data files containing many Gigabytes of data and page in up to four Gigabytes at a time for plotting in the waveform viewer.

However, most editions Microsoft Windows allow a maximum of 2GB of address space for application software despite the fact that 32 bits can address 4GB uniquely. If, as is common, you have 4GB of physical RAM, you can configure Windows to override this default. Under Windows XP and variations, you can edit the boot.ini file to add the "/3GB" option to the operating system line. From <http://www.microsoft.com/whdc/system/platform/server/PAE/PAEmem.mspx>:

Typical boot.ini file:

```
[boot loader]
timeout=30
default=multi(0)disk(0)rdisk(0)partition(2)\WINNT
[operating systems]
```



```
multi(0)disk(0)rdisk(0)partition(2)\WINNT="????? " /3GB
```

Where "?????" would be the programmatic name for one of the following:

Windows XP Professional

Windows Server 2003

Windows Server 2003, Enterprise Edition

Windows Server 2003, Datacenter Edition

Windows 2000 Advanced Server

Windows 2000 Datacenter Server

Windows NT Server 4.0, Enterprise Edition

Microsoft Vista is different and you should use the utility bcdedit.exe, e.g.:

```
C:\Windows\System32>bcdedit.exe /set IncreaseUserVa  
3072
```

The change doesn't take place until the system reboots.

## **LTspice®**

### **LTspice® IV Overview**

LTspice IV is a schematic-driven circuit simulation program. The LTspice simulator was originally based years ago on Berkeley SPICE 3F4/5. The simulator has gone through a complete re-write in order to improve the performance of the simulator, fix bugs, and extend the simulator so that it can run industry standard semiconductor and behavioral models. A digital simulation capability, including co-simulation, has been added. Extensive enhancements have been made to the analog SPICE simulator, such as parallel processing and dynamic assembly and object code

generation in the SPARSE matrix solver to make LTspice IV the industry superlative analog simulator.

Many Linear Technology products are modeled with proprietary building blocks and/or proprietary hardware description languages that accurately encapsulate realistic behavior with **custom macromodels**. This allows a SMPS to be prototyped rapidly via simulation.

LTspice can be used as a general-purpose SPICE simulator. New circuits can be drafted with the built-in **schematic capture**. Simulation commands and parameters are placed as text on the schematic using established **SPICE syntax**. Waveforms of circuit nodes and device currents can be plotted by clicking the mouse on the nodes in the schematic during or after simulation.

An invaluable reference that complements this documentation is the 2nd Edition of *Semiconductor Device Modeling with SPICE* by Giuseppe Massobrio and Paolo Antognetti, McGraw Hill, 1993 and later reprints. That book documents the semiconductor device equations and extensions that have been used in various commercial SPICE programs including those used in this one. For BSIM 3 and 4 devices, see the relevant documentation available from the UC Berkeley CAD group.

LTspice is a registered trademark of Linear Technology Corporation.

## Introduction

### Circuit Description

Circuits are defined by a text netlist. The netlist consists of a list of circuit elements and their nodes, model definitions, and other SPICE commands.

The netlist is usually graphically entered. To start a new schematic, select the File=>Open menu item. A windows file browser will appear. Either select an existing schematic and

save it under a new name or type in a new name to create a new blank schematic file. LTspice uses many different types of files and documents. You will want to make a file with a file name extension of ".asc". The schematic capture commands are under the Edit menu. Keyboard shortcuts for the commands are listed under Schematic Editor Overview.

When you simulate a schematic, the netlist information is extracted from the schematic graphical information to a file with the same name as the schematic but with a file extension of ".net". LTspice reads in this netlist.

You can also open, simulate, and edit a text netlist generated either by hand or externally generated. Files with the extensions ".net", ".cir", or ".sp" are recognized by LTspice as netlists.

This section of the help documents the syntax used in netlists, but occasionally gives schematic-level advice.

## General Structure and Conventions

The circuit to be analyzed is described by a text file called a netlist. The first line in the netlist is ignored, that is, it is assumed to be a comment. The last line of the netlist is usually simply the line ".END", but this can be omitted. Any lines after the line ".END" are ignored.

The order of the lines between the comment and end is irrelevant. Lines can be comments, circuit element declarations or simulation directives. Let's start with an example:

```
* This first line is ignored
* The circuit below represents an RC circuit driven
* with a 1MHz square wave signal
R1 n1 n2 1K ; a 1KOhm resistor between nodes n1 and n2
C1 n2 0 100p ; a 100pF capacitor between nodes n2 and ground
V1 n1 0 PULSE(0 1 0 0 0 .5μ 1μ) ; a 1Mhz square wave
.tran 3μ ; do a 3μs long transient analysis
.end
```

The first two lines are comments. Any line starting with a "\*" is a comment and is ignored. The line starting with "R1" declares that there is a 1K resistor connected between nodes n1 and n2. Note that the semicolon, ";", can be used to start a comment in the middle of a line. The line starting with "C1" declares that there is a 100pF capacitor between nodes n2 and ground. The node "0" is the global circuit common ground.

Below is an overview of the lexicon of LTspice:

- o Letter case, leading spaces, blanks, and tabs are ignored.
  
- o The first non-blank character of a line defines the type of circuit element.

<b>Leading Character</b>	<b>Type of line</b>
*	Comment
A	Special function device
B	Arbitrary behavioral source
C	Capacitor
D	Diode
E	Voltage dependent voltage source
F	Current dependent current source
G	Voltage dependent current source
H	Current dependent voltage source
I	Independent current source
J	JFET transistor
K	Mutual inductance

L	Inductor
M	MOSFET transistor
O	Lossy transmission line
Q	Bipolar transistor
R	Resistor
S	Voltage controlled switch
T	Lossless transmission line
U	Uniform RC-line
V	Independent voltage source
W	Current controlled switch
X	Subcircuit Invocation
Z	MESFET transistor
.	A simulation directive, For example: .options reltol=1e-4
+	A continuation of the previous line. The "+" is removed and the remainder of the line is considered part of the prior line.

Numbers can be expressed not only in scientific notation; e.g., 1e12; but also using engineering multipliers. That is, 1000.0 or 1e3 can also be written as 1K. Below is a table of understood multipliers:

Suffix	Multiplier
T	1e12
G	1e9
Meg	1e6
K	1e3
Mil	25.4e-6
M	1e-3
u(or $\mu$ )	1e-6
n	1e-9
p	1e-12
f	1e-15

The suffixes are not case sensitive. Unrecognized letters immediately following a number or engineering multiplier are ignored. Hence, 10, 10V, 10Volts, and 10Hz all represent the same number, and M, MA, MSec, and MMhos all represent the same scale factor(.001). A common error is to draft a resistor with value of 1M, thinking of a one Megaohm resistor, however, 1M is interpreted as a one milliohm resistor. This is necessary for compatibility with standard SPICE practice.

LTspice will accept numbers written in the form 6K34 to mean 6.34K. This works for any of the multipliers above. It can be turned off by going to Tools=>Control Panel=>SPICE and unchecking "Accept 3K4 as 3.4K".

Nodes names may be arbitrary character strings. Global circuit common node(ground) is "0", though "GND" is special synonym. Note that since nodes are character strings, "0" and "00" are distinct nodes.

Throughout the following sections of the manual, angle brackets are placed around data fields that need to be filled with specific information; for example, "<srcname>" would be the name of some specific source. Square brackets indicate that the enclosed data field is optional.

## Circuit Element Quick Reference

Component	Syntax
Special functions	Axx n1 n2 n3 n4 n5 n6 n7 n8 + <model> [extra parameters]
Arbitrary behavioral source	Bxx n+ n- <V=... or I=...>
Capacitor	Cxx n+ n- <capacitance> + [ic=<val.>] [Rser=<val.>] + [Lser=<val.>] [Rpar=<val.>] + [Cpar=<val.>] [m=<val.>]
Diode	Dxx A K <model> [area]
Voltage dependent voltage	Exx n+ n- nc+ nc- <gain>
Current dependent current	Fxx n+ n- <Vnam> <gain>
Voltage dependent current	Gxx n+ n- nc+ nc- <transcond.>
Current dependent voltage	Hxx n+ n- <Vnam> <transres.>

Independent current source	Ixx n+ n- <current>
JFET transistor	Jxx D G S <model> [area] [off] + [IC=<Vds,Vgs>] [temp=<T>]
Mutual inductance	Kxx L1 L2 L3... <coeff.>
Inductance	Lxx n+ n- <inductance> + [ic=<val.>] [Rser=<val.>] + [Rpar=<val.>] + [Cpar=<val.>] [m=<val.>]
MOSFET transistor	Mxx D G S B <model> [L=<len>] + [W=<width>] [AD=<area>] + [AS=<area>] [PD=<perim>] + [PS=<perim>] [NRD=<value>] + [NRS=<value>] [off] + [IC=<Vds, Vgs, Vbs> + [temp=<T>]
Lossy transmission line	Oxx L+ L- R+ R- <model>
Bipolar transistor	Qxx C B E [S] <model> [area] + [off] [IC=Vbe,Vce][temp=<T>]
Resistor	Rxx n1 n2 <value>
Voltage controlled switch	Sxx n1 n2 nc+ nc- <model> + [on,off]
Lossless transmission line	Txx L+ L- R+ R- ZO=<value> + TD=<value>
Uniform RC-line	Uxx n1 n2 ncommon <model> + L=<len> [N=<lumps>]
Independent voltage source	Vxx n+ n- <voltage>
Current controlled switch	Wxx n1 n2 <Vnam> <model> + [on,off]
Subcircuit	Xxx n1 n2 n3... <subckt name>
MESFET transistor	Zxx D G S model [area] [off] + [IC=<Vds,Vgs>]

## Dot Commands

### C. Simulator Directives -- Dot Commands

To run a simulation, not only must the circuit be defined, but also the type of analysis to be performed. There are six different types of analyses: linearized **small signal AC**, **DC sweep**, **noise**, **DC operating point**, small signal DC transfer function and **transient analysis**. Precisely one of these six analyses must be specified.

Whereas the circuit topology is typically schematically drafted, the commands are usually placed on the schematic as text. All such commands start with a period and are therefore called "dot commands".

## **.AC -- Perform an Small Signal AC Analysis Linearized About the DC Operating Point.**

The small signal(linear) AC portion of LTspice computes the AC complex node voltages as a function of frequency. First, the DC operating point of the circuit is found. Next, linearized small signal models for all of the nonlinear devices in the circuit are found for this operating point. Finally, using independent voltage and current sources as the driving signal, the resultant linearized circuit is solved in the frequency domain over the specified range of frequencies.

This mode of analysis is useful for filters, networks, stability analyses, and noise considerations.

Syntax: `.ac <oct, dec, lin> <Nsteps> <StartFreq> <EndFreq>`

The frequency is swept between frequencies StartFreq and EndFreq. The number of steps is defined with the keyword "oct", "dec", or "lin" and Nsteps according to the following table:

<b>Key</b>	<b>Nsteps</b>
<b>wor</b>	
<b>d</b>	
Oct	No. of steps per octave
Dec	No. of steps per decade
Lin	Total number of linearly spaced steps between StartFreq and EndFr



## **.BACKANNO -- Annotate the Subcircuit Pin Names to the Port Currents**

Syntax: `.backanno`

This directive is automatically included in every netlist LTspice IV generates from a schematic. It directs LTspice to include information in the `.raw` file that can be used to refer to port currents by the pin name. This allows you to plot the current into the pin of a symbol by mouse clicking on the symbol's pin.

## **.DC -- Perform a DC Source Sweep Analysis**

This performs a DC analysis while sweeping the DC value of a source. It is useful for computing the DC transfer function of an amplifier or plotting the characteristic curves of a transistor for model verification.

Syntax: `.dc <srcnam> <Vstart> <Vstop> <Vincr>`  
`+ [<srcnam2> <Vstart2> <Vstop2> <Vincr2>]`

The `<srcnam>` is either an independent voltage or current source that is to be swept from `<Vstart>` to `<Vstop>` in `<Vincr>` step sizes. In the following example, the default BSIM3v3.2.4 characteristic curves are plotted:

```
* Example .dc sweep
*
M1 2 1 0 0 nbsim
Vgs 1 0 3.5
Vds 2 0 3.5
.dc Vds 3.5 0 -0.05 Vgs 0 3.5 0.5
.model nbsim NMOS Level=8
.save I(Vds)
.end
```

## **.END -- End of Netlist**

This directive marks the end of the textual netlist. All lines after this one are ignored. Do not place this as text on the schematic, as the netlist extractor supplies it at the end.

## **.ENDS -- End of Subcircuit Definition**

This directive marks the end of a subcircuit definition. See `.SUBCKT` for more information.

## **.FOUR -- Compute a Fourier Component after a .TRAN Analysis**

Syntax: `.four <frequency> [Nharmonics] [Nperiods] <data trace1> [<data trace2> ...]`

Example: `.four 1kHz V(out)`

This command is performed after a transient analysis. It's supplied in order to be compatible with legacy SPICE simulators. The output from this command is printed in the `.log` file. Use the menu item "View=>Spice Error Log" to see the output. For most purposes, the FFT capability built into the waveform viewer is more useful.

If the integer `Nharmonics` is present, then the analysis includes that number of harmonics. The number of harmonics defaults to 9 if not specified.

The Fourier analysis is performed over the period from the final time, `Tend`, to one period before `Tend` unless an integer `Nperiods` is given after `Nharmonics`. If `Nperiods` is given as `-1`, the Fourier analysis is performed over the entire simulation data range.

## .FUNC -- User Defined Functions

Syntax: `.func <name>([args]) {<expression>}`

Example: `.func Pythag(x,y) {sqrt(x*x+y*y)}`

The `.func` directive allows the creation of user-defined functions for use with user parameterized circuits and behavioral sources. This is useful for associating a name with a function for the sake of clarity and parameterizing subcircuits so that abstract circuits can be saved in libraries.

The `.func` statement can be included inside a subcircuit definition to limit the scope the function to that subcircuit and the subcircuits invoked by that subcircuit.

To invoke parameter substitution and expression evaluation with these user-defined functions, enclose the expression in curly braces. The enclosed expression will be replaced with the floating-point value.

Below is a example using both a `.func` and `.param` statements.

```
* Example deck using a .func statement
.func myfunc(x,y) {sqrt(x*x+y*y)}
.param u=100 v=600
V1 a 0 pulse(0 1 0 1n 1n .5μ 1μ)
R1 a b {myfunc(u,v/3)}
C1 b 0 100p
.tran 3μ
.end
```

All parameter substitution evaluation is done before the simulation begins.

## **.FERRET -- Download a File Given the URL**

This command allows you to download files in batch mode by specifying the urls. This is handy when you don't want to have to point your browser at every file. The downloaded file will be in the same directory as the source schematic or netlist. This command has no effect on the simulation.

```
* example deck
.ferret http://ltspice.linear.com/software/scad3.pdf
.end
```

## **.GLOBAL -- Declare Global Nodes**

Syntax: `.global <node1> [node2 [node3] [...]]`

Example: `.global VDD VCC`

The `.global` command allows you to declare that certain nodes mentioned in subcircuits are not local to subcircuit but are absolute global nodes.

Note that global circuit common is node "0" and that a `.global` statement is not required. Also, node names that of the form "\$G\_" are also global nodes without being mentioned in a `.global` statement.

## **.IC -- Set Initial Conditions**

The `.ic` directive allows initial conditions for transient analysis to be specified. Node voltages and inductor currents may be specified. A DC solution is performed using the initial conditions as constraints. Note that although inductors are normally treated as short circuits in the DC solution in other SPICE programs, if an initial current is specified, they are treated as infinite-impedance current sources in LTspice.

Syntax: `.ic [V(<n1>)=<voltage>] [I(<inductor>)=<current>]`

Example: `.ic V(in)=2 V(out)=5 V(vc)=1.8 I(L1)=300m`

## **.INCLUDE -- Include Another File**

Syntax: `.include <filename>`

This directive includes the named file as if that file had been typed into the netlist instead of the `.include` command. This is useful for including libraries of models or subcircuits.

An absolute path name may be entered for the filename. Otherwise LTspice looks first in the directory `<LTspiceIV> \lib\sub` and then in the directory that contains the calling netlist, where `<LTspiceIV>` is the directory containing the `scad3.exe` executable, typically installed as `C:\Program Files\LTC\LTspiceIV`.

No file name extension is assumed. You must use `".inc myfile.lib"` not `".inc myfile"` if the file is called `"myfile.lib"`

It is possible to specify a url of the following form as a file name:

```
.inc http://www.company.com/models/library.lib
```

The file `"library.lib"` will be http-transferred to the circuit directory and included. For subsequent simulations, in the interest of avoiding downloading the file each time you run the simulation, you can edit the `.inc` statement to

```
.inc library.lib
```

Note that if the url you specify doesn't exist, most web servers don't return an error, but return a html web page to be displayed in your web browser that explains the error. LTspice can't always read these pages as error conditions so you may get some cryptic error message when the simulation tries to proceed with the included html language error page included in the simulation as valid SPICE syntax.

If the http- transferred url is a .pdf file, the simulation will abort after the download. For example the following deck will download this manual as a .pdf file:

```
* Dummy simulation to download the help file.  
* The simulation will abort with an error, but  
* you'll be left with the file scad3.pdf in the  
* same directory containing the netlist.  
.inc http://ltspice.linear.com/software/scad3.pdf  
.end
```

## **.LIB -- Include a Library**

Syntax: `.lib <filename>`

This directive includes the model and subcircuit definitions of the named file as if that file had been typed into the netlist instead of the .lib command. Circuit elements at global scope are ignored.

An absolute path name may be entered for the filename. Otherwise LTspice looks first in the directory <LTspiceIV>\lib\cmp and then <LTspiceIV>\lib\sub and then in the directory that contains the calling netlist, where <LTspiceIV> is the directory containing the scad3.exe executable, typically installed as C:\Program Files\LTC\LTspiceIV.

No file name extension is assumed. You must use ".lib myfile.lib" not ".lib myfile" if the file is called "myfile.lib"

It is possible to specify a URL of the following form as a file name:

```
.lib http://www.company.com/models/library.mod
```

The file "library.mod" will be http-transferred to the circuit directory and included as a library. For subsequent simulations, in the interest of avoiding downloading the file each time you run the simulation, you can edit the .lib statement to

```
.lib library.mod
```

Note that if the URL you specify doesn't exist, most web servers don't return an error, but return a html web page to be displayed in your web browser that explains the error. LTspice can't always read these pages as error conditions so you may get some cryptic error message when the simulation tries to proceed with the included html language error page included in the simulation as valid SPICE syntax.

If the http-transferred URL is a .pdf file, the simulation will abort after the download. For example the following deck will download this manual as a .pdf file:

```
* Dummy simulation to download the help file.  
* The simulation will abort with an error, but  
* you'll be left with the file scad3.pdf in the  
* same directory containing the netlist.  
.lib http://ltspice.linear.com/software/scad3.pdf  
.end
```

## **Encrypted Libraries**

LTspice can generate and read a special form of encrypted libraries. This allows one user to prepare a library that another user can use in a simulation without revealing the implementation of the library. A reasonable attempt has been made to make the encrypted library difficult to decode by unauthorized concerns, but it cannot be considered perfectly secure if for no other reason than it is implemented in software.

To prepare an encrypted library, you need to invoke LTspice from the command line with the command line option "-encrypt". You will need to first backup the library because it will be replaced with the encrypted version. THERE EXISTS NO UTILITY TO CONVERT AN ENCRYPTED LIBRARY BACK TO CLEAR TEXT. Below summarizes the two steps:

1. Make a backup copy of the library. The version you encrypt is deleted.
2. From a command line, type  
scad3.exe -encrypt <filename>

The file <filename> will be replaced with an encrypted version. The encryption process will take a few minutes.

One this process is finished, you have an encrypted ASCII file. It's possible to add a copyright notice above the "\* Begin:" line, but the first 9 lines of the file must remain unchanged and each line of copyright notice you add must begin with the character '\*'.

That is, here an encrypted file written by LTspice:

```
* LTspice Encrypted File
*
* This encrypted file has been supplied by a 3rd
* party vendor that does not wish to publicize
* the technology used to implement this library.
*
* Permission is granted to use this file for
* simulations but not to reverse engineer its
* contents.
*
* Begin:
50 3E 46 0F FA 6E 67 FF B8 4D D9 62 14 32 60 24
36 71 35 0B 66 4F AD 52 B8 F5 9E 22 9F C0 18 8B
FB FE 1D...
```



you can change this to be

```
* LTspice Encrypted File
*
* This encrypted file has been supplied by a 3rd
* party vendor that does not wish to publicize
* the technology used to implement this library.
*
* Permission is granted to use this file for
* simulations but not to reverse engineer its
* contents.
*
* Copyright © 2005 Acme SPICE Modeling
* For additional information, see
* www.acmespicemodels.com
*
* Begin:
50 3E 46 0F FA 6E 67 FF B8 4D D9 62 14 32 60 24
36 71 35 0B 66 4F AD 52 B8 F5 9E 22 9F C0 18 8B
FB FE 1D...
```

## **.LOADBIAS -- Load a Previously Solved DC Solution**

Syntax: `.loadbias <filename>`

The `loadbias` command is the compliment to the `.savebias` command. First run a simulation that executes a `.savebias` command. Then change the `.savebias` command to a `.loadbias` command.

## **.MEASURE -- Evaluate User-Defined Electrical Quantities**

There are two basic different types of `.MEASURE` statements. Those that refer to a point along the abscissa (the independent variable plotted along the horizontal axis, i.e., the time axis of a `.tran` analysis) and `.MEASURE` statements that refer to a range over the abscissa. The first version, those that point to one point on the abscissa, are used to print a data value or expression thereof at a specific point or when a condition is met. The following syntax is used:

Syntax: `.MEAS[SURE] [AC|DC|OP|TRAN|TF|NOISE] <name>`

```

+ [<FIND|DERIV|PARAM> <expr>]
+ [WHEN <expr> | AT=<expr>]]
+ [TD=<vall>] [<RISE|FALL|CROSS>=[<count1>|LAST]]

```

Note one can optionally state the type of analysis to which the .MEAS statement applies. This allows you to use certain .MEAS statements only for certain analysis types. The name is required to give the result a parameter name that can be used in other .MEAS statements. Below are example .MEAS statements that refer to a single point along the abscissa:

```
.MEAS TRAN res1 FIND V(out) AT=5m
```

Print the value of V(out) at t=5ms labeled as res1.

```
.MEAS TRAN res2 FIND V(out)*I(Vout) WHEN V(x)=3*V(y)
```

Print the value of the expression V(out)\*I(Vout) the first time the condition V(x)=3\*V(y) is met. This will be labeled res2.

```
.MEAS TRAN res3 FIND V(out) WHEN V(x)=3*V(y) cross=3
```

Print the value of V(out) the third time the condition V(x)=3\*V(y) is met. This will be labeled res3.

```
.MEAS TRAN res4 FIND V(out) WHEN V(x)=3*V(y) rise=last
```

Print the value of V(out) the last time the condition V(x)=3\*V(y) is met when approached as V(x) increasing wrt 3\*V(y). This will be labeled res4.

```
.MEAS TRAN res5 FIND V(out) WHEN V(x)=3*V(y) cross=3 TD=1m
```

Print the value of V(out) the third time the condition V(x)=3\*V(y) is met, but don't start counting until the time as elapsed to 1ms. This will be labeled res5.

```
.MEAS TRAN res6 PARAM 3*res1/res2
```

Print the value of  $3*res1/res2$ . This form is useful for printing expressions of other .meas statement results. It's not intended that expressions based on direct simulation data, such as  $V(3)$ , are present in the expression to be evaluated, but if they are, the data is taken from the last simulated point. The result will be labeled res6.

Note that the above examples, while referring to one point along the abscissa, the requested result is based on ordinate data (the dependent variables). If no ordinate information is requested, then the .MEAS statement prints point on the abscissa that the measurement condition occurs:

```
.MEAS TRAN res6 WHEN V(x)=3*V(y)
```

Print the first time the condition  $V(x)=3*V(y)$  is met. This will be labeled res6.

The other type of .MEAS statement refers to a range over the abscissa. The following syntax is used:

```
Syntax:  .MEAS [AC|DC|OP|TRAN|TF|NOISE] <name>
          +      [<AVG|MAX|MIN|PP|RMS|INTEG> <expr>]
          + [TRIG <lhs1> [[VAL]=]<rhs1>] [TD=<val1>]
          +      [<RISE|FALL|CROSS>=<count1>]
          + [TARG <lhs2> [[VAL]=]<rhs2>] [TD=<val2>]
          +      [<RISE|FALL|CROSS>=<count2>]
```

The range over the abscissa is specified with the points defined by "TRIG" and "TARG". The TRIG point defaults to the start of the simulation if omitted. Similarly, the TARG point defaults to the end of simulation data. If all three of the TRIG, TARG, and the previous WHEN points are omitted, then the .MEAS statement operates over the entire range of data. The types of measurement operations that can be done over an interval are

<b>Keyw ord</b>	<b>Operation perform over interval</b>
AVG	Compute the average of <expr>
MAX	Find the maximum value of <expr>

```

MIN Find the minimum value of <expr>
PP Find the peak-to-peak of <expr>
RMS Compute the root mean square of <expr>
INTE Integrate <expr>
G

```

If no measurement operation is specified, the result of the .MEAS statement is the distance along the abscissa between the TRIG and TARG points. Below are example interval .MEAS statements:

```

.MEAS TRAN res7 AVG V(NS01)
+ TRIG V(NS05) VAL=1.5 TD=1.1u FALL=1
+ TARG V(NS03) VAL=1.5 TD=1.1u FALL=1

```

Print the value of average value of V(NS01) from the 1<sup>st</sup> fall of V(NS05) to 1.5V after 1.1us and the 1st fall of V(NS03) to 1.5V after 1.1us. This will be labeled res7.

For .AC analyses, the conditional expressions of complex data are translated to real conditions by converting the expression to its magnitude. So in this example:

```

.MEAS AC rel8 when V(out)=1/sqrt(2)

```

The result rel8 is the frequency that the magnitude of V(out) is equal to 0.7071067811865475.

Also, the result of a .MEAS statement can be used in another .MEAS statement. In this example, the 3dB bandwidth is computed:

```

.MEAS AC tmp max mag(V(out)); find the peak response
;
; and call it "tmp"
.MEAS AC BW trig mag(V(out))=tmp/sqrt(2) rise=1
+ targ mag(V(out))=tmp/sqrt(2) fall=last

```

Print the difference in frequency between the two points 3dB down from peak response. NOTE: The data from a .AC analysis is complex and so are the .measurement statements results. However, the equality refers only to the real part of the complex number, that is, "mag(V(out))=tmp/sqrt(2)" is equivalent to  $\text{Re}(\text{mag}(V(\text{out}))) = \text{Re}(\text{tmp}/\sqrt{2})$ .

The AVG, RMS, and INTEG operations are different for .NOISE analysis than the analysis types since the noise is more meaningfully integrated in quadrature over frequency. Hence AVG and RMS both give the RMS noise voltage and INTEG gives the integrated total noise. Hence, if you add the SPICE directives

```
.MEAS NOISE out_totn INTEG V(onoise)
.MEAS NOISE in_totn INTEG V(inoise)
```

to a .noise analysis, the total integrated input and output referenced rms noise will be printed in the .log file.

.MEAS statements are done in post processing after the simulation is completed. This allows you to write a script of .MEAS statements and execute them on a dataset. To do this, make the waveform window the active window and execute menu command File=>Execute .MEAS Script. Another consequence of .MEAS statements being done in post processing after the simulation is that the accuracy of the .MEAS statement output is limited by the accuracy of the waveform data after compression. You may want to adjust the compression settings for more precise .MEAS statement output.

Note when testing a condition such as "when <cond1> = <cond2>" you will want the condition to go through the equality, not must meet it. This relates to the fact that floating point equality should never be required due to the finite precision used in storing numbers.

**.MODEL -- Define a SPICE Model**

Defines a model for a diode, transistor, switch, lossy transmission line or uniform RC line

Some circuit elements, for example, transistors, have many parameters. Instead of defining every transistor parameter for every instance of a transistor, transistors are grouped by model name and have parameters in common. The transistors of the same model can have different sizes and the electrical behavior is scaled to the size of the instance.

Syntax: `.model <modname> <type>[(<parameter list>)]`

The model name must be unique. That is, two different types of circuit elements, such as a diode and a transistor, cannot have the same model name. The parameter list depends on the type of model. Below is a list of model types:

<b>Type</b>	<b>Associated Circuit Element</b>
SW	Voltage Controlled Switch
CSW	Current Controlled Switch
URC	Uniform Distributed RC Line
LTRA	Lossy Transmission Line
D	Diode
NPN	NPN Bipolar Transistor
PNP	PNP Bipolar Transistor
NJF	N-channel JFET model
PJF	P-channel JFET model
NMOS	N-channel MOSFET
PMOS	P-channel MOSFET
NMF	N-channel MESFET
PMF	P-channel MESFET
VDMOS	Vertical Double Diffused Power MOSFET

See the description of the circuit element for a list of which parameters are instance specific and which are common to a model.

**.NET -- Compute Network Parameters in a .AC Analysis**

This statement is used with a small signal(.AC) analysis to compute the input and output admittance, impedance, Y-parameters, Z-parameters, H-parameters, and S-parameters of a 2-port network. It can also be used to compute the input admittance and impedance of a 1-port network. This must be used with a .AC statement, which determines the frequency sweep of the network analysis.

```
Syntax: .net [V(out[,ref])|I(Rout)] <Vin|Iin>
+       [Rin=<val>] [Rout=<val>]
```

The network input is specified by either an independent voltage source, <Vin>, or an independent current source, <Iin>. The optional output port is specified either with a node, V(out), or a resistor, I(Rout). The ports will be terminated with resistances Rin and Rout. If unspecified, the termination impedances default to 1 Ohm except in the case of the Voltage source with an Rser specified or an output port specified with a resistor. In those two cases the termination resistances defaults to the device impedance. Termination values specified on the .NET statement will override device impedances for the .NET calculation, but not for the normal .AC node voltages and currents. That is, the .NET statement will not impose terminating impedances on the network for the normal voltages and currents computed as part of the .AC analysis.

See the example file typically installed as C:\Program Files\LTC\LTPspiceIV\examples\Educational\S-param. It recommends using a voltage source, V4, with Rser set the desired source impedance and a resistor, Rout, to set the output termination with a .NET statement reading simply ".net I(Rout) V4." No Rin or Rout values specified on the .net statement and the input/output devices supply default termination values. This arrangement makes the node voltages and currents of the .AC analysis correspond to the network being terminated in the same manner as in the .NET statement.

## **.NODESET -- Supply Hints for Initial DC Solution**

The .nodeset directive supplies hints for finding the DC operating point. If a circuit has multiple possible DC states as, for example, a flipflop, the iteration process

for finding the DC solution may never converge. A `.nodeset` directive can be used to lead the circuit to one or another state. Basically, after a solution pass is done with the voltage specified on the `nodeset` directive, the constraint is removed for subsequent iterative passes.

Syntax: `.NODESET V(node1)=<voltage> [V(node2)=<voltage> [...]]`

## **.NOISE -- Perform a Noise Analysis**

This is a frequency domain analysis that computes the noise due to Johnson, shot and flicker noise. The output data is noise spectral density per unit square root bandwidth.

Syntax: `.noise V(<out>[,<ref>]) <src> <oct, dec, lin>  
+ <Nsteps> <StartFreq> <EndFreq>`

`V(<out>[,<ref>])` is the node at which the total output noise is calculated. It can be expressed as `V(n1, n2)` to represent the voltage between two nodes. `<src>` is the name of an independent source to which input noise is referred. `<src>` is the noiseless input signal. The parameters `<oct, dec, lin>`, `<Nsteps>`, `<StartFreq>`, and `<EndFreq>` define the frequency range of interest and resolution in the manner used in the `.ac` directive.

Output data trace `V(onoise)` is the noise spectral voltage density referenced to the node(s) specified as the output in the above syntax. If the input signal is given as a voltage source, then data trace `V(inoise)` is the input-referred noise voltage density. If the input is specified as a current source, then the data trace `inoise` is the noise referred to the input current source signal. The noise contribution of each component can be plotted. These contributions are referenced to the output. You can reference them to the input by dividing by the data trace "gain".



The waveform viewer can integrate noise over a bandwidth by <Ctrl-Key> + left mouse button clicking on the corresponding data trace label.

## **.OP -- Find the DC Operating Point**

Perform a DC operating point solution with capacitances open circuited and inductances short circuited. Usually a DC solution is performed as part of another analysis in order to find the operating point of the circuit. Use .op if you wish only this operating point to be found. The results will appear in a dialog box. After a .OP simulation, when you point at a node or current the .OP solution will appear on the status bar.

There is no guarantee that the operating point of a general nonlinear circuit can be found with successive linear approximations as is done in Newton-Raphson iteration. Should direct Newton iteration fail, LTspice tries a number of other methods to find an operating point. Below is a table of the methods used and the options settings required to disable a particular method.

<b>Method</b>	<b>Directive to disable</b>
Direct Newton Iteration	.options NoOpIter
Adaptive Gmin Stepping	.options GminSteps=0
Adaptive Source Stepping	.options SrcSteps=0
Pseudo Transient	.options pTranTau=0

## **.OPTIONS -- Set Simulator Options**

<b>Keyword</b>	<b>Data Type</b>	<b>Default Value</b>	<b>Description</b>
abstol	Num.	1pA	Absolute current error tolerance
baudrate	Num.	(none)	Used for eye diagrams. Tells

the waveform viewer how to wrap the abscissa time to overlay the bit transitions.

chgtol	Num.	10fC	Absolute charge tolerance
cshunt	Num.	0.	Optional capacitance added from every node to ground
cshuntintern	Num.	cshunt	Optional capacitance added from every device internal node to ground.
defad	Num.	0.	Default MOS drain diffusion area
defas	Num.	0.	Default MOS source diffusion area
defl	Num.	100µm	Default MOS channel length
defw	Num.	100µm	Default MOS channel width
delay	Num.	0.	Used for eye diagrams. Shifts the bit transitions in the diagram.
fastaccess	flag	false	Convert to fastaccess file format at end of simulation.
flagloads	flag	false	Flags external current sources as loads.
Gmin	Num.	1e-12	Conductance added to every PN junction to aid convergence.
gminsteps	Num.	25	Set to zero to prevent gminstepping for the initial DC solution.
gshunt	Num.	0.	Optional conductance added from every node to ground.
itl1	Num.	100	DC iteration count limit.
itl2	Num.	50	DC transfer curve iteration count limit.
itl4	Num.	10	Transient analysis time point iteration count limit
itl6	Num.	25	Set to zero to prevent source

			stepping for the initial DC solution.
srcsteps	Num.	25	Alternative name for itl6.
maxclocks	Num.	Infin.	maximum number of clock cycles to save
maxstep	Num.	Infin.	Maximum step size for transient analysis
meascplxfmt	string	bode	Complex number format of .meas statement results. One of "polar", "cartesian", or "bode".
measdgt	Num.	6	Number of significant figures used for .measure statement output.
method	string	trap	Numerical integration method, either trapezoidal or Gear
minclocks	Num.	10	minimum number of clock cycles to save
MinDeltaGmin	Num.	1e-4	Sets a limit for termination of adaptive gmin stepping.
nomarch	flag	false	Do not plot marching waveforms
noopiter	flag	false	Go directly to gmin stepping.
numdgt	Num.	6	Historically "numdgt" was used to set the number of significant figures used for output data. In LTspice, if "numdgt" is set to be > 6, double precision is used for dependent variable data.
pivrel	Num.	1e-3	Relative ratio between the largest column entry and an acceptable pivot value.
pivtol	Num.	1e-13	Absolute minimum value for a matrix entry to be accepted as a pivot.

reltol	Num.	.001	Relative error tolerance.
srcstepmethod	Num.	0	Which source stepping algorithm to start with.
sstol	Num.	.001	Relative error for steady-state detection.
startclocks	Num.	5	Number of clock cycles to wait before looking for steady state.
temp	Num.	27°C	Default temperature for circuit element instances that don't specify temperature.
tnom	Num.	27°C	Default temperature at which device parameters were measured for models that don't specify this temperature.
topologycheck	Num.	1	Set to zero to skip check for floating nodes, loops of voltage sources, and non-physical transformer winding topology
trtol	Num.	1.0	Set the transient error tolerance. This parameter is an estimate of the factor by which the actual truncation error is overestimated.
trytocompact	Num.	1	When non-zero, the simulator tries to condense LTRA transmission lines' history of input voltages and currents.
vntol	Num.	1μV	Sets the absolute voltage error tolerance.
plotreltol	Num.	.0025	Sets the relative error tolerance for waveform compression.
plotvntol	Num.	10μV	Sets the absolute voltage

			error tolerance for waveform compression.
plotabstol	Num.	1nA	Sets the absolute current error tolerance for waveform compression.
plotwinsize	Num.	300	Number of data points to compress in one window. Set to zero to disable compression.
ptransau	Num.	.1	Characteristic source start-up time for a damped pseudo transient analysis to find the operating point. Set to zero to disable pseudo transient.
ptranmax	Num.	0	If set non-zero, that time of the damped pseudo transient analysis is used as the operating point whether the circuit has settled or not.

## **.PARAM -- User-Defined Parameters**

The `.param` directive allows the creation of user-defined variables. This is useful for associating a name with a value for the sake of clarity and parameterizing subcircuits so that abstract circuits can be saved in libraries.

The `.param` statement can be included inside a subcircuit definition to limit the scope the parameter value to that subcircuit.

To invoke parameter substitution and expression evaluation, enclose the expression in curly braces. The enclosed expression will be replaced with the floating-point value.

Below is a example using both a .param statement and directly passing parameters on the subcircuit invocation line.

```
*
* This is the circuit definition
.params x=y y=z z=1k*tan(pi/4+.1)
X1 a b 0 divider top=x bot=z
V1 a 0 pulse(0 1 0 .5μ .5μ 0 1μ)

* this is the definition of the subcircuit
.subckt divider n1 n2 n3
r1 n1 n2 {top}
r2 n2 n3 {bot}
.ends
*

.tran 3μ
.end
```

The parameter substitution scheme is a symbolic declarative language. The parameters are not passed to the subcircuit as evaluated values, but by the expressions and relations themselves. When curly braces are encountered, the enclosed expression is evaluated on the basis of all relations available at the scope and reduced to a floating point value.

The following functions and operations are available:

Function Name	Description
abs(x)	Absolute value of x
acos(x)	Real part of the arc cosine of x, e.g., acos(-5) returns 3.14159, not 3.14159+2.29243i
arccos(x)	Synonym for acos()
acosh(x)	Real part of the arc hyperbolic cosine of x, e.g., acosh(.5) returns 0, not 1.0472i
asin(x)	Real part of the arc sine of x,

	e.g., <code>asin(-5)</code> returns <code>-1.57080</code> , not <code>-1.57080+2.29243i</code>
<code>arcsin(x)</code>	Synonym for <code>asin()</code>
<code>asinh(x)</code>	Arc hyperbolic sine
<code>atan(x)</code>	Arc tangent of <code>x</code>
<code>arctan(x)</code>	Synonym for <code>atan()</code>
<code>atan2(y, x)</code>	Four quadrant arc tangent of <code>y/x</code>
<code>atanh(x)</code>	Arc hyperbolic tangent
<code>buf(x)</code>	1 if <code>x &gt; .5</code> , else 0
<code>cbrt(x)</code>	Cube root of ( <code>x</code> )
<code>ceil(x)</code>	Integer equal or greater than <code>x</code>
<code>cos(x)</code>	Cosine of <code>x</code>
<code>cosh(x)</code>	Hyperbolic cosine of <code>x</code>
<code>exp(x)</code>	<code>e</code> to the <code>x</code>
<code>fabs(x)</code>	Same as <code>abs(x)</code>
<code>flat(x)</code>	Random number between <code>-x</code> and <code>x</code> with uniform distribution
<code>floor(x)</code>	Integer equal to or less than <code>x</code>
<code>gauss(x)</code>	Random number from Gaussian distribution with sigma of <code>x</code> .
<code>hypot(x,y)</code>	<code>sqrt(x**2 + y**2)</code>
<code>if(x,y,z)</code>	If <code>x &gt; .5</code> , then <code>y</code> else <code>z</code>
<code>int(x)</code>	Convert <code>x</code> to integer
<code>inv(x)</code>	0. if <code>x &gt; .5</code> , else 1.
<code>limit(x,y,z)</code>	Intermediate value of <code>x</code> , <code>y</code> , and <code>z</code>
<code>ln(x)</code>	Natural logarithm of <code>x</code>
<code>log(x)</code>	Alternate syntax for <code>ln()</code>
<code>log10(x)</code>	Base 10 logarithm
<code>max(x,y)</code>	The greater of <code>x</code> or <code>y</code>

<code>mc(x,y)</code>	A random number between $x*(1+y)$ and $x*(1-y)$ with uniform distribution.
<code>min(x,y)</code>	The smaller of $x$ or $y$
<code>pow(x,y)</code>	Real part of $x**y$ , e.g., <code>pow(-.5,1.5)</code> returns 0., not 0.353553i
<code>pwr(x,y)</code>	<code>abs(x)**y</code>
<code>pwrs(x,y)</code>	<code>sgn(x)*abs(x)**y</code>
<code>rand(x)</code>	Random number between 0 and 1 depending on the integer value of $x$ .
<code>random(x)</code>	Similar to <code>rand()</code> , but smoothly transitions between values.
<code>round(x)</code>	Nearest integer to $x$
<code>sgn(x)</code>	Sign of $x$
<code>sin(x)</code>	Sine of $x$
<code>sinh(x)</code>	Hyperbolic sine of $x$
<code>sqrt(x)</code>	Real part of the square root of $x$ , e.g., <code>sqrt(-1)</code> returns 0, not 0.707107i
<code>table(x,a,b,c,d,...)</code>	Interpolate a value for $x$ based on a look up table given as a set of pairs of points.
<code>tan(x)</code>	Tangent of $x$ .
<code>tanh(x)</code>	Hyperbolic tangent of $x$
<code>u(x)</code>	Unit step, i.e., 1 if $x > 0.$ , else 0.
<code>uramp(x)</code>	$x$ if $x > 0.$ , else 0.

The following operations are grouped in reverse order of precedence of evaluation:



<b>Ope ran d</b>	<b>Description</b>
&	Convert the expressions to either side to Boolean, then AND.
	Convert the expressions to either side to Boolean, then OR.
^	Convert the expressions to either side to Boolean, then XOR.
>	True if expression on the left is greater than the expression on the right, otherwise false.
<	True if expression on the left is less than the expression on the right, otherwise false.
>=	True if expression on the left is less than or equal the expression on the right, otherwise false.
<=	True if expression on the left is greater than or equal the expression on the right, otherwise false.
+	Floating point addition
-	Floating point subtraction
*	Floating point multiplication
/	Floating point division
**	Raise left hand side to power of right hand side, only real part is returned, e.g., -2**1.5 returns zero, not 2.82843i

## **.SAVE -- Limit the Quantity of Saved Data.**

Some simulations, particularly time domain simulations, can generate large amount of data. The amount of output can be restricted by using the .save directive to save only the specific node voltages and device current of interest.

Syntax: `.save V(out) [V(in) [I(L1) [I(S2)]]] [dialogbox]`

The directive `.save I(Q2)` will save the base, collector and emitter currents of bipolar transistor Q2. To save a single terminal current, specify `Ic(Q2)`.

The wildcard characters '\*' and '?' can be used to specify data traces matching a pattern. For example, `".save V(*) Id(*)"` will save every voltage and every drain current.

If the keyword "dialogbox" is specified, then a dialog box with a list of all-available default nodes and currents is displayed allowing the user to select from the list which should be saved. If the netlist was generated from a schematic, then nodes and devices can be pointed to and clicked on in the schematic to highlight them as selected in the dialog box.

## **.SAVEBIAS -- Save Operating Point to Disk**

Syntax: `.savebias <filename> [internal]`  
`+ [temp=<value>] [time=<value> [repeat]] [step=<value>]`  
`+ [DC1=<value>] [DC2=<value>] [DC3=<value>]`

This command writes a text file to disk that is reloaded with a `.loadbias` command in a subsequent simulation. If you have a circuit that has a difficult-to-solve DC operating point, you can save that solution to disk so that the next analysis can save time finding the DC solution before proceeding to the rest of the simulation.

The keyword "internal" can be added to indicate that the internal nodes of some devices should also be kept so that a more complete version of the DC solution is kept.

If you want to save a particular DC operating point from a .tran analysis, you can give specify a time. The first solved time point after the stipulated time will be written. The modifier "repeat" will cause the DC solution to be written after every period specified by this time. The file will contain only the most recently solved DC point. DC1, DC2, and DC3 can be given to extract a single operating point from .dc sweep analysis.

The savebias command writes a text file in the form of a .nodeset command. Note that nodeset statements are only recommendations of the solution. That is, the solver will start iterating the solution with the node voltages given in the nodeset statements, but will continue iterating until it's satisfied that the solution is valid. If you want to restart a .tran solution from the DC operating point, you can edit the file from a .nodeset to a .ic to try to coerce the solver to start from this DC state.

Since the integration state of all the circuit reactances isn't saved in the .savebias file, success with this technique varies.

## **.STEP -- Parameter Sweeps**

This command causes an analysis to be repeatedly performed while stepping the temperature, a model parameter, a global parameter, or an independent source. Steps may be linear, logarithmic, or specified as a list of values.

Example: `.step oct v1 1 20 5`

Step independent voltage source V1 from 1 to 20 logarithmically with 5 points per octave.

Example: `.step I1 10u 100u 10u`

Step independent current source I1 from 10u to 100u in step increments of 10u.

Example: `.step param RLOAD LIST 5 10 15`

Perform the simulation three times with global parameter Rload being 5, 10 and 15.

Example: `.step NPN 2N2222(VAF) 50 100 25`

Step NPN model parameter VAF from 50 to 100 in steps of 25.

Example: `.step temp -55 125 10`

Step the temperature from -55°C to 125°C in 10-degree step. Step sweeps may be nested up to three levels deep.

## **.SUBCKT -- Define a Subcircuit**

As an aid to defining a circuit, repetitive circuitry can be enclosed in a subcircuit definition and used as multiple instances in the same circuit. Before the simulation runs, the circuit is expanded to a flat netlist by replacing each invocation of a subcircuit with the circuit elements in the subcircuit definition. There is no limit on the size or complexity of subcircuits.

The end of a subcircuit definition must be a `.ends` directive.

Here is an example using a subcircuit:

```

*
* This is the circuit definition
X1 a b 0 divider
V1 a 0 pulse(0 1 0 .5μ .5μ 0 1μ)

* this is the definition of the subcircuit
.subckt divider n1 n2 n3
r1 n1 n2 1k
r2 n2 n3 1k
.ends

.tran 3μ
.end

```

Which runs after expanding to

```

* Expand X1 into two resistor network
r:1:1 a b 1k
r:1:2 b 0 1k
*
v1 a 0 pulse(0 1 0 .5μ .5μ 0 1μ)
.tran 3μ
.end

```

Note that unique names based on the subcircuit name and the subcircuit definition element names are made for the circuit elements inserted by subcircuit expansion.

## .TEMP -- Temperature Sweeps

This is an archaic form for the step command for temperature. It performs the simulation for each temperature listed.

The syntax

```
.TEMP <T1> <T2> ...
```

is equivalent to

```
.STEP TEMP LIST <T1> <T2> ...
```

## .TF -- Find the DC Small Signal Transfer Function

This is an analysis mode that finds the DC small signal transfer function of a node voltage or branch current due to small variations of an independent source.

```
Syntax:  .TF V(<node>[, <ref>]) <source>
         .TF I(<voltage source>) <source>
```

Examples:

```
.TF V(out) Vin
.TF V(5,3) Vin
.TF I(Vload) Vin
```

## .TRAN -- Perform a Nonlinear Transient Analysis

Perform a transient analysis. This is the most direct simulation of a circuit. It basically computes what happens when the circuit is powered up. Test signals are often applied as independent sources.

```
Syntax:  .TRAN <Tstep> <Tstop> [Tstart [dTmax]] [modifiers]
         .TRAN <Tstop> [modifiers]
```

The first form is the traditional .tran SPICE command. Tstep is the plotting increment for the waveforms but is also used as an initial step-size guess. LTspice uses waveform compression, so this parameter is of little value and can be omitted or set to zero. Tstop is the duration of the simulation. Transient analyses always start at time equal to zero. However, if Tstart is specified, the waveform data between zero and Tstart is not saved. This is a means of managing the size of waveform files by allowing startup transients to be ignored.

The final parameter `dTmax`, is the maximum time step to take while integrating the circuit equations. If `Tstart` or `dTmax` is specified, `Tstep` must be specified.

Several **modifiers** can be placed on the `.tran` line.

## **.WAVE -- Write Selected Nodes to a .Wav File.**

LTspice can write `.wav` audio files. These files can then be listened to or be used as the input of another simulation.

Syntax: `.wave <filename.wav> <Nbits> <SampleRate> V(out)  
[V(out2) ...]`

example: `.wave C:\output.wav 16 44.1K V(left) V(right)`

`<filename.wav>` is either a complete absolute path for the `.wav` file you wish to create or a relative path computed from the directory containing the simulation schematic or netlist. Double quotes may be used to specify a path containing spaces. `<Nbits>` is the number of sampling bits. The valid range is from 1 to 32 bits.

`<SampleRate>` is the number of samples to write per simulated second. The valid range is 1 to 4294967295 samples per second. The remainder of the syntax lists the nodes that you wish to save. Each node will be an independent channel in the `.wav` file. The number of channels may be as few as one or as many as 65535. It is possible to write a device current, e.g., `Ib(Q1)` as well as node voltage. The `.wav` analog to digital converter has a full scale range of -1 to +1 Volt or Amp.

Note that it is possible to write `.wav` files that cannot be played on your PC sound system because of the number of channels, sample rate or number of bits due to limitations of your PC's codec. But these `.wav` files may still be used in LTspice as input for another simulation. See the sections `LTspice=>Circuit Elements=>V. Voltage Source` and `I. Current source` for information on playing a `.wav` file into an LTspice simulation. If you want to play the `.wav` file on your PC sound card, keep in mind that the more popularly supported `.wav` file formats have 1 or 2 channels; 8 or 16 bits/channel; and a sample rate of 11025, 22050, or 44100 Hz.

# Transient Analysis Options

## .TRAN Modifiers

**UIC**: Skip the D.C. operating solution and use user-specified initial conditions.

**steady**: Stop the simulation when steady state has been reached.

**nodiscard**: Don't delete the part of the transient simulation before steady state is reached.

**startup**: Solve the initial operating point with independent voltage and current sources turned off. Then start the transient analysis and turn these sources on in the first 20 us of the simulation.

**step**: Compute the step response of the circuit.

## UIC

Use Initial Conditions. Normally, a DC operating point analysis is performed before starting the transient analysis. This directive suppresses this initialization. The initial conditions of some circuit elements can be specified on an instance-per-instance basis. Uic is not a particularly recommended feature of SPICE. Skipping the DC operating point analysis leads to a nonphysical initial condition. For example, consider a voltage source connected in parallel to a capacitance. The node voltage is taken as zero if not specified. Then, in the first time step, an infinite current is required to charge the capacitor. The simulator cannot find a short enough time step to make the current nonsingular, and a "time step too small convergence fail" message is issued.

## startup

This is similar to SPICE's original "uic". It means that independent sources should be ramped on during the first 20 $\mu$ s of the simulation. However, a DC operating point analysis is performed using the constraints specified on a .ic directive.



## steady

Stop the simulation when steady state has been reached. This is required for an efficiency calculation report. Steady state detection is written into the SMPS macromodels. Typically they are written to look for zero error amp output current averaged over a clock cycle. The algorithm takes the error amp's output compliance range into consideration. The fraction of peak current that is considered zero current is specified with the `sstol` option.

The automatic steady state detection can fail either by being too critical or not critical enough. You can interactively specify steady state in the following manner: As soon as the simulation starts, execute menu command `Simulate=>Efficiency Calculation=>Mark Start`. The first time you execute this command you tell LTspice you're going to manually specify the integration limits. After the circuit looks like it's reached steady-state, execute that command again. That will clear the history and restart the Efficiency Calculation. Then, after awhile, as in you see well more than 10 clock cycles, execute `Simulate=>Efficiency Calculation=>Mark End`. Each time you execute `Simulate=>Efficiency Calculation=>Mark Start` you restart the efficiency calculation and clear the waveform history. This is a good method of preventing the data file from becoming too large and slowing down plotting, so it's recommended that you periodically execute `Simulate=>Efficiency Calculation=>Mark Start` whenever it is clear that you've accumulated substantial data that you don't want to be included in the integration of efficiency.

Use the `.ic` directive to specify node voltages and inductor currents to reduce the length of the transient analysis required to find the steady state.

## nodiscard

Don't delete the part of the transient simulation before steady state is reached.

## step

Compute the step response of the circuit. This function works with a current source used as a load with a list of step currents. The procedure is:

- 1) compute to steady state and discard the history unless `nodiscard` is set.
- 2) ramp the step load to the next value in the list of currents at the rate of 20A/ $\mu$ s.
- 3) compute to steady state
- 4) change the step load to the next value in the list or quit if there is none.

Due to the circuit complexity, the automatic STEP transition might not be detectable. Under this circumstance, it is best to use the `.TRAN` command to run the transient simulation and observe the starting and ending periods of the desired step load response. Use `PWL` command to program the output load current and switches to different levels at desired time periods. For example:

```
PWL(0 0.5 1m 0.5 1.01m 0.1 3m 0.1 3.01m 0.5)
```

The load current starts with 0.5A at time 0,

stays at 0.5A at 1ms,

switches to 0.1A at time 1.01ms,

stays at 0.1A until 3ms,

and switches to 0.5A at 3.01ms and stays at 0.5A.

The `PWL` can have almost unlimited pairs of (time, value) sequence.

## Circuit Elements

### A. Special Functions.

Symbol names: INV, BUF, AND, OR, XOR, SCHMITT, SCHMTBUF, SCHMTINV, DFLOP, VARISTOR, and MODULATE

Syntax: Annn n001 n002 n003 n004 n005 n006 n007 n008 <model>  
[instance parameters]

These are Linear Technology Corporation's proprietary special function/mixed mode simulation devices. Most of these and their behavior are undocumented as they frequently change with each new set of models available for LTspice. However, here we document some of them because of their general interest.

INV, BUF, AND, OR, and XOR are generic idealized behavioral gates. All gates are netlisted with eight terminals. These gates require no external power. Current is sourced or sunk from the complementary outputs, terminals 6 and 7, and returned through device common, terminal 8. Terminals 1 through 5 are inputs. Unused inputs and outputs are to be connected to terminal 8. The digital device compiler recognizes that as a flag that that terminal is not used and removes it from the simulation. This leads to the potentially confusing situation where AND gates act differently when an input is grounded or at zero volts. If ground is the gate's common, then the grounded input is not at a logic false condition, but simply not part of the simulation. The reason that these gates are implemented like that is that this allows one device to act as 2-, 3-, 4- or 5- input gates with true, inverted, or complementary output with no simulation speed penalty for unused terminals. That is, the AND device acts as 12 different types of AND gates. The gates default to 0V/1V logic with a logic threshold of .5V, no propagation delay, and a 10hm output impedance. Output characteristics are set with these instance parameters:

Name	Default	Description
Vhigh	1	Logic high level
Vlow	0	Logic low level
Trise	0	Rise time

Tfall	Tri se	Fall time
Tau	0	Output RC time constant
Cout	0	Output capacitance
Rout	1	Output impedance
Rhigh	Rou t	Logic high level impedance
Rlow	Rou t	Logic low level impedance

Note that not all parameters can be specified on the same instance at the same time, e.g., the output characteristics are either a slewing rise time or an RC time constant, not both.

The propagation delay defaults to zero and is set with instance parameter Td. Input hold time is equal to the propagation delay.

The input logic threshold defaults to  $.5*(V_{high}+V_{low})$  but can be set with the instance parameter Ref. The hold time is equal to the propagation delay.

The exclusive XOR device has non-standard behavior when more than two inputs are used: The output is true only when exactly one of all inputs is true. Use the associative property of XOR's with multiple XOR devices to implement an XOR block with more than two inputs.

The Schmitt trigger devices have similar output characteristics as the gates. Their trip points are specified with instance parameters Vt and Vh. The low trip point is  $V_t - V_h$  and the high trip point is  $V_t + V_h$ .

The gates and Schmitt trigger devices supply no timestep information to the simulation engine by default. That is, they

don't look when they are about to change state and make sure there's a timestep close to either side of the state change. The instance parameter `tripdt` can be set to stipulate a maximum timestep size the simulator takes across state changes.

The VARISTOR is a voltage controlled varistor. Its breakdown voltage is set by the voltage between terminals 1 and 2. Its breakdown impedance is specified with the instance parameter `rclamp`. See the example schematic `.\examples\Educational\varistor.asc`

The MODULATE device is a voltage controlled oscillator. See the example schematic `.\examples\Educational\PLL.asc`. The instantaneous oscillation frequency is set by the voltage on the FM input. The conversion from voltage to frequency is linear and set by the two instance parameters, `mark` and `space`. `mark` is the frequency when the FM input is at 1V and `space` is the frequency when the input is at 0V. The amplitude is set by the voltage on the AM input and defaults to 1V if that input is unused (connected to the MODULATE common).

The schematic capture aspect of LTspice netlists symbols for these devices in a special manner. All unconnected terminals are automatically connected to terminal 8. Also, if terminal 8 is unconnected, then it is connected to node 0.

## B. Arbitrary behavioral voltage or current sources.

Symbol names: BV, BI

```
Syntax:  Bnnn n001 n002 V=<expression> [ic=<value>]
         + [tripdv=<value>] [tripdt=<value>]
         + [laplace=<expression> [window=<time>]]
         + [nfft=<number>] [mtol=<number>]]
```

```
Bnnn n001 n002 I=<expression> [ic=<value>]
         + [tripdv=<value>] [tripdt=<value>] [Rpar=<value>]
         + [laplace=<expression> [window=<time>]]
         + [nfft=<number>] [mtol=<number>]]
```

The first syntax specifies a behavioral voltage source and the next is a behavioral current source. For the current source, a parallel resistance may be specified with the Rpar instance parameter.

Tripdv and tripdt control step rejection. If the voltage across a source changes by more than tripdv volts in tripdt seconds, that simulation time step is rejected.

Expressions can contain the following:

- o Node voltages, e.g., V(n001)
- o Node voltage differences, e.g., V(n001, n002)
- o Circuit element currents; for example, I(S1), the current through switch S1 or Ib(Q1), the base current of Q1. However, it is assumed that the circuit element current is varying quasi-statically, that is, there is no instantaneous feedback between the current through the referenced device and the behavioral source output. Similarly, any ac component of such a device current is assumed to be zero in a small signal linear .AC analysis.
- o The keyword, "time" meaning the current time in the simulation.
- o The keyword, "pi" meaning 3.14159265358979323846.
- o The following functions:

Function Name	Description
abs(x)	Absolute value of x

<code>absdelay(x,t[,tmax ])</code>	x delayed by t. Optional max delay notification tmax.
<code>acos(x)</code>	Real part of the arc cosine of x, e.g., <code>acos(-5)</code> returns 3.14159, not 3.14159+2.29243i
<code>arccos(x)</code>	Synonym for <code>acos()</code>
<code>acosh(x)</code>	Real part of the arc hyperbolic cosine of x, e.g., <code>acosh(.5)</code> returns 0, not 1.0472i
<code>asin(x)</code>	Real part of the arc sine of x, <code>asin(-5)</code> is -1.57080, not -1.57080+2.29243i
<code>arcsin(x)</code>	Synonym for <code>asin()</code>
<code>asinh(x)</code>	Arc hyperbolic sine
<code>atan(x)</code>	Arc tangent of x
<code>arctan(x)</code>	Synonym for <code>atan()</code>
<code>atan2(y, x)</code>	Four quadrant arc tangent of y/x
<code>atanh(x)</code>	Arc hyperbolic tangent
<code>buf(x)</code>	1 if x > .5, else 0
<code>ceil(x)</code>	Integer equal or greater than x
<code>cos(x)</code>	Cosine of x
<code>cosh(x)</code>	Hyperbolic cosine of x
<code>ddt(x)</code>	Time derivative of x
<code>delay(x,t[,tmax])</code>	Same as <code>absdelay()</code>
<code>exp(x)</code>	e to the x
<code>floor(x)</code>	Integer equal to or less than x
<code>hypot(x,y)</code>	$\sqrt{x^2 + y^2}$
<code>idt(x[,ic[,a]])</code>	Integrate x, optional initial condition ic, reset if a is true.
<code>idtmod(x[,ic[,m[,o ]])</code>	Integrate x, optional initial condition ic, reset on reaching

	modulus m, offset output by o.
<code>if(x,y,z)</code>	If $x > .5$ , then y else z
<code>int(x)</code>	Convert x to integer
<code>inv(x)</code>	0. if $x > .5$ , else 1.
<code>limit(x,y,z)</code>	Intermediate value of x, y, and z
<code>ln(x)</code>	Natural logarithm of x
<code>log(x)</code>	Alternate syntax for <code>ln()</code>
<code>log10(x)</code>	Base 10 logarithm
<code>max(x,y)</code>	The greater of x or y
<code>min(x,y)</code>	The smaller of x or y
<code>pow(x,y)</code>	Real part of $x^{**y}$ , e.g., <code>pow(-1,.5)=0</code> , not i.
<code>pwr(x,y)</code>	$\text{abs}(x)^{**y}$
<code>pwrs(x,y)</code>	$\text{sgn}(x) * \text{abs}(x)^{**y}$
<code>rand(x)</code>	Random number between 0 and 1 depending on the integer value of x.
<code>random(x)</code>	Similar to <code>rand()</code> , but smoothly transitions between values.
<code>round(x)</code>	Nearest integer to x
<code>sdt(x[,ic[,assert] ])</code>	Alternate syntax for <code>idt()</code>
<code>sgn(x)</code>	Sign of x
<code>sin(x)</code>	Sine of x
<code>sinh(x)</code>	Hyperbolic sine of x
<code>sqrt(x)</code>	Square root of x
<code>table(x,a,b,c,d,.. .)</code>	Interpolate a value for x based on a look up table given as a set of pairs of points.
<code>tan(x)</code>	Tangent of x.



<code>tanh(x)</code>	Hyperbolic tangent of <code>x</code>
<code>u(x)</code>	Unit step, i.e., 1 if <code>x &gt; 0.</code> , else 0.
<code>uramp(x)</code>	<code>x</code> if <code>x &gt; 0.</code> , else 0.
<code>white(x)</code>	Random number between <code>-.5</code> and <code>.5</code> smoothly transitions between values even more smoothly than <code>random()</code> .
<code>!(x)</code>	Alternative syntax for <code>inv(x)</code>
<code>~(x)</code>	Alternative syntax for <code>inv(x)</code>

- o The following operations, grouped in reverse order of precedence of evaluation:

<b>Ope ran d</b>	<b>Description</b>
<code>&amp;</code>	Convert the expressions to either side to Boolean, then AND.
<code> </code>	Convert the expressions to either side to Boolean, then OR.
<code>^</code>	Convert the expressions to either side to Boolean, then XOR.
<code>&gt;</code>	True if expression on the left is greater than the expression on the right, otherwise false.
<code>&lt;</code>	True if expression on the left is less than the expression on the right, otherwise false.
<code>&gt;=</code>	True if expression on the left is less than or equal the expression on the right, otherwise false.
<code>&lt;=</code>	True if expression on the left is greater than or equal the expression on the right, otherwise false.

+	Floating point addition
-	Floating point subtraction
*	Floating point multiplication
/	Floating point division
**	Raise left hand side to power of right hand side. Only the real part is returned, e.g., $-1^{**1.5}$ gives zero not $i$ .
!	Convert the following expression to Boolean and invert.

True is numerically equal to 1 and False is 0. Conversion to Boolean converts a value to 1 if the value is greater than 0.5, otherwise the value is converted to 0.

Note that LTspice uses the caret character,  $\wedge$ , for Boolean XOR and  $^{**}$  for exponentiation. Also, LTspice distinguishes between exponentiation,  $x^{**}y$ , and the function `pwr(x,y)`. Some 3rd party simulators have an incorrect implementation of behavioral exponentiation, evaluating  $-3^{**}3$  incorrectly to 27 instead of -27, presumably in the interest of avoiding the problem of exponentiating a negative number to a non-integer power. LTspice handles this issue by returning the real part of the result of the exponentiation. E.g.,  $-2^{**}1.5$  evaluates to zero which is the real part of the correct answer of  $2.82842712474619i$ . This means that when you import a 3rd party model that was targeted at a 3rd party simulator, you may need to translate the syntax such as  $x^y$  to  $x^{**}y$  or even `pwr(x,y)`.

If an optional Laplace transform is defined, that transform is applied to the result of the behavioral current or voltage. The Laplace transform must be a function solely of  $s$ . The Boolean

XOR operator, ^, is understood to mean exponentiation, \*\*, when used in a Laplace expression. The frequency response at frequency  $f$  is found by substituting  $s$  with  $\sqrt{-1} \cdot 2\pi \cdot f$ . The time domain behavior is found from the sum of the instantaneous current (or voltage) with the convolution of the history of this current (or voltage) with the impulse response. Numerical inversion of a Laplace transfer function to the time domain impulse response is a potentially compute-bound process and a topic of current numerical research. In LTspice, the impulse response is found from the FFT of a discrete set points in frequency domain response. This process is prone to the usual artifacts of FFT's such as spectral leakage and picket fencing that is common to discrete FFT's. LTspice uses a proprietary algorithm that exploits that it has an exact analytical expression for the frequency domain response and chooses points and windows to cause such artifacts to diffract precisely to zero. However, LTspice must guess an appropriate frequency range and resolution. It is recommended that the LTspice first be allowed to make a guess at this. The length of the window and number of FFT data points used will be reported in the .log file. You can then adjust the algorithm's choices by explicitly setting `nfft` and window length. The reciprocal of the value of the window is the frequency resolution. The value of `nfft` times this resolution is the highest frequency considered. Note that the convolution of the impulse response with the behavioral source is also potentially a compute bound process.

### C. Capacitor

Symbol names: CAP, POLCAP

```
Syntax: Cnnn n1 n2 <capacitance> [ic=<value>]
        + [Rser=<value>] [Lser=<value>] [Rpar=<value>]
        + [Cpar=<value>] [m=<value>]
        + [RLshunt=<value>] [temp=<value>]
```

It is possible to specify an equivalent series resistance, series inductance, parallel resistance and parallel shut capacitance. The equivalent circuit is given below:

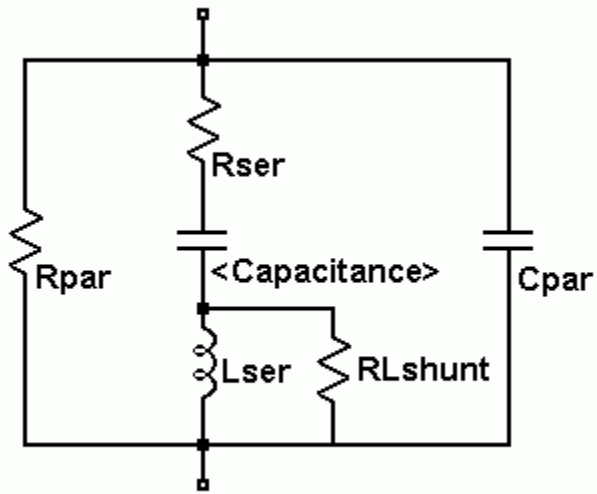

### Capacitor Instance Parameters

Parameter Name	Description
Rser	Equivalent series resistance
Lser	Equivalent series inductance
Rpar	Equivalent parallel resistance
Cpar	Equivalent parallel capacitance
RLshunt	Shunt resistance across Lser
m	Number of parallel units
temp	Instance temperature(for tempcos in a corresponding .model statement)
ic	Initial voltage(used only if uic is flagged on the .tran card)

It is computationally better to include the parasitic Rpar, Rser, RLshunt, Cpar and Lser in the capacitor than to explicitly draft them. LTspice uses proprietary circuit simulation technology to simulate this model of a physical capacitor without any internal nodes. This makes the simulation matrix smaller, faster to solve, and less likely to be singular at short time steps.

Note that since the capacitor element includes these parasitics, it is useful for macromodeling the fundamental of a piezoelectric crystal.

There is also a general nonlinear capacitor available. Instead of specifying the capacitance, one writes an expression for the charge.

LTspice will compile this expression and symbolically differentiate it with respect to all the variables, finding the partial derivative's that correspond to capacitances.

Syntax: Cnnn n1 n2 Q=<expression> [ic=<value>] [m=<value>]

There is a special variable, x, that means the voltage across the device. Therefore, a 100pF constant capacitance can be written as

```
Cnnn n1 n2 Q=100p*x
```

A capacitance with an abrupt change from 100p to 300p at zero volts can be written as

```
Cnnn n1 n2 Q=x*if(x<0,100p,300p)
```

This device is useful for rapidly evaluating the behavior of a new a hypothetical charge model for, e.g., a transistor.

## D. Diode

Symbol Names: DIODE, ZENER, SCHOTTKY, VARACTOR.

Syntax: Dnnn anode cathode <model> [area]  
+ [off] [m=<val>] [n=<val>] [temp=<value>]

Examples:

```
D1 SW OUT MyIdealDiode
```

```
.model MyIdealDiode D(Ron=.1 Roff=1Meg Vfwd=.4)
```

```
D2 SW OUT dio2
```

```
.model dio2 D(Is=1e-10)
```

Instance parameter M sets the number of parallel devices while instance parameter N sets the number of series devices.

A diode requires a .model card to specify its characteristics. There are two types of diodes available. One is a conduction region-wise linear model that yields a computationally light weight representation of an idealized diode. It has three linear regions of conduction: on, off and reverse breakdown. Forward conduction and reverse breakdown can non-linear by specifying a current limit with Ilimit(revIlimit). tanh() is used to fit the slope of the forward conduction to the limit current. The parameters epsilon and revepsilon can be specified to smoothly switch between the off and conducting states. A quadratic function is fit between the off and on state such that the diode's IV curve is continuous in value and slope and the transition occurs over a voltage specified by the value of epsilon for the off to forward conduction and revepsilon for the transition between off and reverse breakdown.

Below are the model parameters for this type of diode:

Name	Description	Units	Default
Ron	Resistance in forward conduction	$\Omega$	1.
Roff	Resistance when off	$\Omega$	1./Gmin
Vfwd	Forward threshold voltage to enter conduction	V	0.
Vrev	Reverse breakdown voltage	V	Inf.
Rrev	Breakdown impedance	$\Omega$	Ron
Ilimit	Forward current limit	A	Inf.
Revlimit	Reverse current limit	A	Inf.
Epsilon	Width of quadratic region	V	0.
Repsilon	Width of reverse quad. region	V	0.

This idealized model is used if any of Ron, Roff, Vfwd, Vrev or Rrev is specified in the model.

The other model available is the standard Berkeley SPICE semiconductor diode but extended to handle more detailed breakdown behavior and recombination current. The area factor determines the number of equivalent parallel devices of a specified model. Below are the diode model parameters for this diode.

Name	Description	Units	Default	Example
Is	saturation current	A	1e-14	1e-7

Rs	Ohmic resistance	$\Omega$	0.	10.
N	Emission coefficient	-	1	1.
Tt	Transit-time	sec	0.	2n
Cj o	Zero-bias junction cap.	F	0	2p
Vj	Junction potential	V	1.	.6
M	Grading coefficient	-	0.5	0.5
Eg	Activation energy	eV	1.1 1	1.11 Si 0.69 Sbd 0.67 Ge
Xt i	Sat.-current temp. exp	-	3.0	3.0 jn 2.0 Sbd
Kf	Flicker noise coeff.	-	0	
Af	Flicker noise exponent	1	1	
Fc	Coeff. for forward-bias depletion capacitance formula	-	0.5	
BV	Reverse breakdown voltage	V	Inf in.	40.
Ib v	Current at breakdown voltage	A	1e- 10	
Tn om	Parameter measurement temp.	$^{\circ}\text{C}$	27	50
Is r	Recombination current parameter	A	0	



Nr	Isr emission coeff.	-	2
I <sub>kf</sub>	High-injection knee current	A	Inf in.
T <sub>ikf</sub>	Linear I <sub>kf</sub> temp coeff.	/°C	0
T <sub>rs1</sub>	linear R <sub>s</sub> temp coeff.	/°C	0
T <sub>rs2</sub>	Quadratic R <sub>s</sub> temp coeff.	/°C/ °C	0

It is possible to specify voltage, current, and power dissipation ratings for a model. These model parameters do not affect the electrical behavior. They allow LTspice to check if the diode is being used beyond its rated capability. The following parameters apply to either model. These parameters do not scale with area.

<b>Na me</b>	<b>Description</b>	<b>Un it s</b>
V <sub>pk</sub>	Peak voltage rating	V
I <sub>pk</sub>	Peak current rating	A
I <sub>ave</sub>	Ave current rating	A
I <sub>rms</sub>	RMS current rating	A
d <sub>iss</sub>	Maximum power dissipation rating	W

## E. Voltage Dependent Voltage Source

Symbol Names: E, E2

There are three types of voltage-dependent voltage-source circuit elements.

Syntax: Exxx n+ n- nc+ nc- <gain>

This circuit element asserts an output voltage between the nodes n+ and n- that depends on the input voltage between nodes nc+ and nc-. This is a linearly dependent source specified solely by a constant gain.

Syntax: Exxx n+ n- nc+ nc- table=(<value pair>, <value pair>, ...)

A look-up table is used to specify the transfer function. The table is a list of pairs of numbers. The second value of the pair is the output voltage when the control voltage is equal to the first value of that pair. The output is linearly interpolated when the control voltage is between specified points. If the control voltage is beyond the range of the look-up table, the output voltage is extrapolated as a constant voltage of the last point of the look-up table.

Syntax: Exxx n+ n- nc+ nc- Laplace=<func(s)>  
+ [window=<time>] [nfft=<number>] [mtol=<number>]

The transfer function of this circuit element is specified by its Laplace transform. The Laplace transform must be a function of  $s$ . The frequency response at frequency  $f$  is found by substituting  $s$  with  $\sqrt{-1} \cdot 2\pi \cdot f$ . The time domain behavior is found from the impulse response found from the Fourier transform of the frequency domain response. LTspice must guess an appropriate frequency range and resolution. The response must drop at high frequencies or an error is reported. It is recommended that the LTspice first be allowed to make a guess at this and then check the accuracy by reducing `reltol` or explicitly setting `nfft` and the window. The reciprocal of the value of the window is the frequency resolution.

The value of `nfft` times this resolution is the highest frequency considered. The Boolean XOR operator, "`^`" is understood to mean exponentiation "`**`" when used in a Laplace expression.

Syntax: `Exxx n+ n- value={<expression>}` This is an alternative syntax of the behavioral source, arbitrary behavioral voltage source, B.

Syntax: `Exxx n+ n- POLY(<N>) <(node1+,node1-)<br>(node2+,node2-)<br>+ ... (nodeN+,nodeN-)> <c0 c1 c2 c3 c4 ...>`

This is an archaic means of arbitrary behavioral modeling with a polynomial. It is useful for running existing Linear Technology behavioral models.

Note: It is better to use a G source shunted with a resistance to approximate an E source than to use an E source. A voltage controlled current source shunted with a resistance will compute faster and cause fewer convergence problems than a voltage controlled voltage source. Also, the resultant nonzero output impedance is more representative of a practical circuit.

## F. Current Dependent Current Source

Symbol Name: F

Syntax: `Fxxx n+ n- <Vnam> <gain>`

This circuit element applies a current between nodes `n+` and `n-`. The current applied is equal to the value of the gain times the current through the voltage source specified as `<Vnam>`.

Syntax: `Fxxx n+ n- value={<expression>}`

This is an alternative syntax of the behavioral source, arbitrary behavioral voltage source, B.

Syntax: Fxxx n+ n- POLY(<N>) <V1 V2 ... VN> <c0 c1 c2 c3  
c4 ...>

This is an archaic means of arbitrary behavioral modeling with a polynomial. It is useful for running existing Linear Technology behavioral models.

## G. Voltage Dependent Current Source

Symbol Names: G, G2

There are three types of voltage dependent current-source circuit elements.

Syntax: Gxxx n+ n- nc+ nc- <gain>

This circuit element asserts an output current between the nodes n+ and n- that depends on the input voltage between nodes nc+ and nc-. This is a linearly dependent source specified solely by a constant gain.

Syntax: Gxxx n+ n- nc+ nc- table=(<value pair>, <value pair>, ...)

Here a lookup table is used to specify the transfer function. The table is a list of pairs of numbers. The second value of the pair is the output current when the control voltage is equal to the first value of that pair. The output is linearly interpolated when the control voltage is between specified points. If the control voltage is beyond the range of the look-up table, the output current is extrapolated as a constant current of the last point of the look-up table.

Syntax: Gxxx n+ n- nc+ nc- Laplace=<func(s)>  
+ [window=<time>] [nfft=<number>] [mtol=<number>]

The transfer function of this circuit element is specified by its Laplace transform. The Laplace transform must be a function of  $s$ . The frequency response at frequency  $f$  is found by substituting  $s$  with  $\sqrt{-1} * 2 * \pi * f$ . The time-domain behavior is found from the impulse response, which is found from the Fourier transform of the frequency-domain response. LTspice must guess an appropriate frequency range and resolution. The response must drop at high frequencies or an error is reported. It is recommended that the LTspice first be allowed to make a guess at this and then check the accuracy by reducing `reltol` or explicitly setting `nfft` and `window`. The reciprocal of the value of `window` is the frequency resolution. The value of `nfft` times this resolution is the highest frequency considered. The Boolean XOR operator, "`^`" is understood to mean exponentiation "`**`" when used in a Laplace expression.

Syntax: `Gxxx n+ n- value={<expression>}` This is an alternative syntax of the behavioral source, arbitrary behavioral voltage source, B.

Syntax: `Gxxx n+ n- POLY(<N>) <(node1+,node1-)<br>(node2+,node2-)<br>+ ... (nodeN+,nodeN-)> <c0 c1 c2 c3 c4 ...>`

This is an archaic means of arbitrary behavioral modeling with a polynomial. It is useful for running existing Linear Technology behavioral models.

## H. Current Dependent Voltage Source

Symbol Name: H

Syntax: `Hxxx n+ n- <Vnam> <transresistance>`

This circuit element applies a voltage between nodes `n+` and `n-`. The voltage applied is equal to the value of the gain times the current through the voltage source `<Vnam>`.

Syntax: `Hxxx n+ n- value={<expression>}`

This is an alternative syntax of the behavioral source, arbitrary behavioral voltage source, B.

Syntax: Hxxx n+ n- POLY(<N>) <V1 V2 ... V3> <c0 c1 c2 c3 c4 ...>

This is an archaic means of arbitrary behavioral modeling with a polynomial. It is useful for running existing Linear Technology behavioral models.

## I. Current Source

Symbol Name: CURRENT

Syntax: Ixxx n+ n- <current> [AC=<amplitude>] [load]

This circuit element sources a constant current between nodes n+ and n-. If the source is flagged as a load, the source is forced to be dissipative, that is, the current goes to zero if the voltage between nodes n+ and n- goes to zero or a negative value. The purpose of this option is to model a current load on a power supply that doesn't draw current if the output voltage is zero.

For AC analysis, the value of AC is used as the amplitude of the source at the analysis frequency.

Syntax: Ixxx n+ n- PULSE(Ioff Ion Tdelay Trise Tfall Ton Tperiod Ncycles)

Time-dependent pulsed current source

<b>Nam e</b>	<b>Description</b>	<b>Un it s</b>
Iof	Initial value	A

f		
Ion	Pulsed value	A
Tdelay	Delay	sec
Tr	Rise time	sec
Tf	Fall time	sec
Ton	On time	sec
Tperiod	Period	sec
Ncycles	Number of cycles(Omit for free-running pulse function)	cycles

Syntax: Ixxx n+ n- SINE(Ioffset Iamp Freq Td Theta Phi Ncycles)

Time-dependent sine wave current source.

<b>Name</b>	<b>Description</b>	<b>Units</b>
Ioffset	DC offset	A
Iamp	Amplitude	A
Freq	Frequency	Hz
Td	Delay	sec
Theta	Damping factor	1/sec

Phi	Phase of sine wave	degrees
Ncycles	Number of cycles(Omit for free-running pulse function)	cycles

For times less than Td or times after completing Ncycles, have run, the output current is given by Ioffset+Iamp\*sin(pi\*phi/180) Otherwise the current is given by

$$I_{offset} + I_{amp} * \exp(-(time - T_d) * \Theta) * \sin(2 * \pi * Freq * (time - T_d) + \pi * \phi / 180)$$

The damping factor, Theta, is the reciprocal of the decay time constant.

Syntax: Ixxx n+ n- EXP(I1 I2 Td1 Tau1 Td2 Tau2)

Time-dependent exponential current source

Name	Description	Units
I1	Initial value	A
I2	Pulsed value	A
Td1	Rise delay time	sec
Tau1	Rise-time constant	sec
Td2	Fall delay time	sec
Tau2	Fall-time constant	sec



For times less than Td1, the output current is I1. For times between Td1 and Td2 the current is given by

$$I1+(I2-I1)*(1-\exp(-(time-Td1)/Tau1)).$$

For times after Td2 the current is given by

$$I1+(I2-I1)*(1-\exp(-(time-Td1)/Tau1)) \\ + (I1-I2)*(1-\exp(-(time-Td2)/Tau2)).$$

Syntax: Ixxx n+ n- SFFM(Ioff Iamp Fcar MDI Fsig)

Time-dependent single-frequency FM current source.

<b>Nam e</b>	<b>Description</b>	<b>Un it s</b>
Iof f	DC offset	A
Iam p	Amplitude	A
Fca r	Carrier frequency	Hz
MDI	Modulation index	-
Fsi g	Signal frequency	Hz

The current is given by

$$Ioff+Iamp*\sin((2.*pi*Fcar*time)+MDI*\sin(2.*pi*Fsig*time)).$$

Syntax: Ixxx n+ n- tbl=(<voltage, current>, <voltage, current>, ...)

The current can also be specified as a function of the voltage across the output nodes with a look-up table. This is useful for modeling the characteristics of a load.

Syntax: Ixxx n+ n- <value> step(<value1>, [<value2>], [<value3>, ...]) [load]

This is a special form for the current source. The current is specified as a list of currents to use in a step load response transient analysis. In this mode, the simulation is computed until steady state is reached at the first current in the list, <value1>. Then the current is stepped to the next value in the list, <value2>. The simulation proceeds until steady state is achieved at that current. Then the current is stepped to the next value and the process repeats until the list is exhausted. If the .tran command doesn't specify "step", then the original <value> is used.

Syntax: Ixxx n+ n- R=<value>

This is not a current source at all, but a resistor. It is used to model a resistive load when the load is netlisted as a current source.

Syntax: Ixxx n+ n- PWL(t1 i1 t2 i2 t3 i3...)

Arbitrary Piece-wise linear current source.

For times before t1, the current is i1. For times between t1 and t2, the current varies linearly between i1 and i2. There

can be any number of time, current points given. For times after the last time, the current is the last current.

Syntax: Ixxx n+ n- wavfile=<filename> [chan=<nnn>]

This allows a .wav file to be used as an input to LTspice. <filename> is either a full, absolute path for the .wav file or a relative path computed from the directory containing the simulation schematic or netlist. Double quotes may be used to specify a path containing spaces. The .wav file may contain up to 65536 channels, numbered 0 to 65535. Chan may be set to specify which channel is used. By default, the first channel, number 0, is used. The .wav file is interpreted as having a full scale range from -1A to 1A.

This source only has meaning in a .tran analysis.

## J. JFET transistor

Symbol Names: NJF, PJF

Syntax: Jxxx D G S <model> [area] [off] [IC=Vds, Vgs]  
[temp=T]

Examples:

```
J1 0 in out MyJFETmodel
```

```
.model MyJFETmodel NJF(Lambda=.001)
```

```
J2 0 in out MyPJFETmodel
```

```
.model MyPJFETmodel PJF(Lambda=.001)
```

A JFET transistor requires a `.model` card to specify its characteristics. Note that the model card keywords NJF and PJF specify the polarity of the transistor. The area factor determines the number of equivalent parallel devices of a specified model.

The JFET model is derived from the FET model of Shichman and Hodges extended to include Gate junction recombination current and impact ionization. The DC characteristics are defined by the parameters VTO and BETA, which determine the variation of drain current with gate voltage; LAMBDA, which determines the output conductance; and Is, the saturation current of the two gate junctions. Two ohmic resistances, Rd and Rs, are included. Charge storage is modeled by nonlinear depletion layer capacitances for both gate junctions; which vary as the  $-1/2$  power of junction voltage and are defined by the parameters Cgs, Cgd, and PB. A fitting parameter B has been added. See A. E. Parker and D. J. Skellern, An Improved FET Model for Computer Simulators, IEEE Trans CAD, vol. 9, no. 5, pp. 551-553, May 1990.

<b>Na me</b>	<b>De scri ption</b>	<b>U n i t s</b>	<b>Def aul t</b>	<b>Exam ple</b>
Vto	Threshold voltage	V	-2. 0	-2.0
Bet a	Transconductance parameter	A / V / V	1e- 4	1e-3
Lam bda	Channel-length modulation parameter	1 / V	0	1e-4
Rd	Drain ohmic resistance	$\Omega$	0.	100
Rs	Source ohmic resistance	$\Omega$	0.	100
Cgs	Zero-bias G-S junction capacitance	F	0.	5p
Cgd	Zero-bias G-D junction capacitance	F	0.	1p

Pb	Gate junction potential	V	1.	0.6
Is	Gate junction saturation current	A	1e-14	1e-14
B	Doping tail parameter	-	1	1.1
KF	Flicker noise coefficient	-	0	
AF	Flicker noise exponent	-	1	
Fc	Coefficient for forward-depletion capacitance	-	.5	
Tnom	Parameter measurement temperature	°C	27	50
BetaTce	Transconductance parameter exponential temperature coefficient	% / °C	0	
Vt0Tc	Threshold voltage temperature coefficient	V / °C	0	
N	Gate junction emission coefficient	-	1.	
Isr	Gate junction recombination current parameter	A	0.	
Nr	Emission coefficient for Isr	-	2	
alpha	Ionization coefficient	1 / V	0	
Vk	Ionization knee	V	0	

	voltage		
Xti	Saturation current	-	3
	temperature		
	coefficient		

## K. Mutual Inductance

Symbol Names: None, this is placed as text on the schematic.

Syntax: Kxxx L1 L2 [L3 ...] <coefficient>

L1 and L2 are the names of inductors in the circuit. The mutual coupling coefficient must be in the range of -1 to 1.

The line

```
K1 L1 L2 L3 L4 1.
```

is synonymous with the six lines

```
K1 L1 L2 1.
K2 L2 L3 1.
K3 L3 L4 1.
K4 L1 L3 1.
K5 L2 L4 1.
K6 L1 L4 1.
```

It is recommended to start with a mutual coupling coefficient equal to 1. This will eliminate leakage inductance that can ring at extremely high frequencies if damping is not supplied and slow the simulation. However, a mutual inductance value of -1 or 1 can lead to simulation difficulties if the uic directive is flagged on the .tran card.

## L. Inductor

Symbol Names: IND, IND2

```
Syntax: Lxxx n+ n- <inductance> [ic=<value>]
        + [Rser=<value>] [Rpar=<value>]
        + [Cpar=<value>] [m=<value>] [temp=<value>]
```

It is possible to specify an equivalent series resistance, series inductances, parallel resistance and parallel shut capacitance. The equivalent circuit is given below:

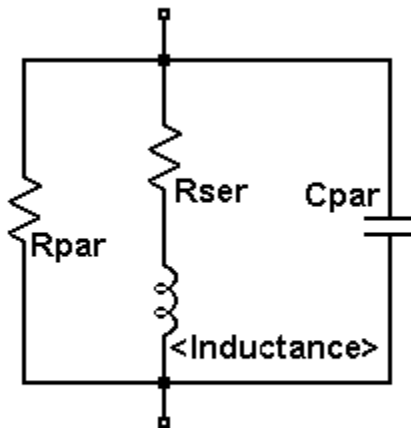

### Inductor Instance Parameters

Name	Description
Rser	Equivalent series resistance
Rpar	Equivalent parallel resistance

Cp	Equivalent parallel capacitance
ar	
m	Number of parallel units
ic	Initial current(used only if uic flagged on the .tran card)
tc	Linear inductance temperature coeff.
1	
Tc	Quadratic inductance temperature coeff.
1	
te	Instance temp
mp	

It is better to include the device parasitics Rpar, Rser, and Cpar in the inductor than to explicitly draft them. LTspice uses proprietary circuit simulation technology to simulate this physical inductor without any internal nodes. This makes the simulation matrix smaller, faster to compute and less likely to be singular over all time-step sizes.

By default, LTspice will supply losses to inductors to aid SMPS transient analysis. For SMPS, these losses are of usually of no consequence, but may be turned off if desired. On the "Tools=> Control Panel=>Hacks!" page, uncheck "Supply a min. inductor damping if no Rpar is given." This setting will be remembered between invocations of the program. There is also a default series resistance of 1 milliohm for inductors that aren't mentioned in a mutual inductance statement. This Rser allows LTspice IV to integrate the inductance as a Norton equivalent circuit instead of Thevenin equivalent in order to reduce the size of the circuit's linearized matrix. If you don't want LTspice to introduce this minimum resistance, you must explicitly set Rser=0 for that inductor. This will require LTspice to use the more cumbersome Thevenin equivalent of the inductor during transient analysis.

There are two forms of non-linear inductors available in LTspice. One is a behavioral inductance specified with an



expression for the flux. The inductor's current is referred to by the keyword "x" in the expression. Below is an example in a netlist.

```
*
L1 N001 0 Flux=1m*tanh(5*x)
I1 0 N001 PWL(0 0 1 1)
.tran 1
.end
```

In the above example, I1 supplies a unity dI/dT so that the inductance can be read off as the voltage on node N001.

There other non-linear inductor available in LTspice is a hysteretic core model based on a model first proposed in by John Chan et la. in IEEE Transactions On Computer-Aided Design, Vol. 10. No. 4, April 1991 but extended with the methods in United States Patent 7,502,723. This model defines the hysteresis loop with only three parameters:

<b>N</b>	<b>Description</b>	<b>Units</b>
<b>a</b>		
<b>m</b>		
<b>e</b>		
H	Coercive force	Amp-turns/mete
c		r
B	Remnant flux density	Tesla
r		
B	Saturation flux density	Tesla
s		

The upper and lower branches of the hysteresis major loop are given by

$$B_{up}(H) = B_s \cdot \frac{H + H_c}{|H+H_c| + H_c \cdot (B_s/B_r - 1)} + \mu_0 \cdot H$$

and

$$B_{dn}(H) = B_s \cdot \frac{H - H_c}{|H - H_c| + H_c \cdot (B_s / B_r - 1)} + \mu_0 \cdot H$$

These functions are plotted in following figure.  $H_c$  and  $B_r$  are the intersections of the major hysteresis loop with the H- and B-axes.  $B_s$  is the B-axis intersection of the asymptotic line,  $B_{sat}(H) = B_s + \mu_0 \cdot H$ , approached as H goes to infinity.

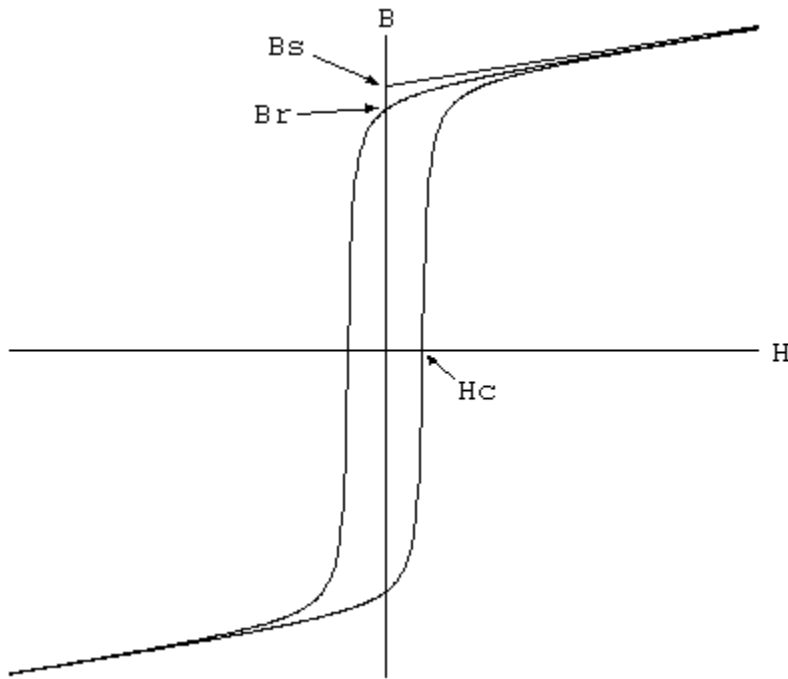

The initial magnetization curve is given by

$$B_{mag}(H) = .5 \cdot (B_{up}(H) + B_{dn}(H))$$

Minor loops are obtained by various translations of the above equations per the cited reference. The core's absolute and differential permeabilities are a function of H and the history of values of H. The plot below shows the path taken by an asymmetrical minor loop for a typical power ferrite ( $H_c=16$  A-turns/m,  $B_s=.44T$ ,  $B_r= .10T$ ).

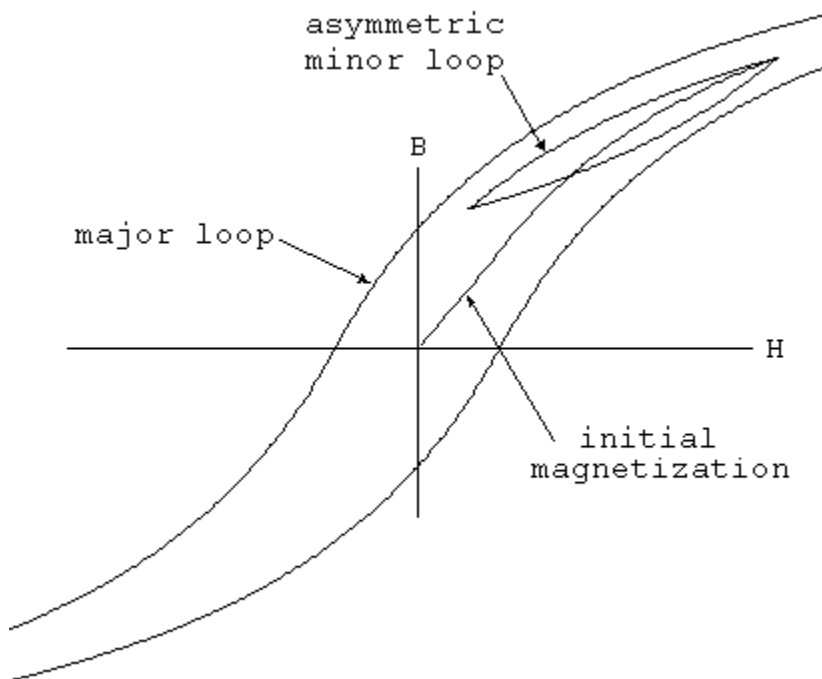

In addition to the core property parameters  $H_c$ ,  $B_r$ , and  $B_s$ , mechanical dimensions of the core are required:

Name	Description	Units
$L_m$	Magnetic Length(excl. gap)	meter
$L_g$	Length of gap	meter
$A$	Cross sectional area	meter* *2
$N$	Number of turns	-

Note that if specifying a non-zero gap the magnetic field,  $H$ , is not proportional to the current in the windings. LTspice solves for the magnetic fields in the core and gap under the assumption of uniform cross sectional area and thin or uniformly distributed gap.

Below is an example that shows inductance vs. current for L1, an inductor wound on a gapped core. You can read out the inductance as V(n001) since current source I1 supplies a unity dI/dt. The core follows the initial magnetization curve, so you can see that the permeability first increases from the initial value as the current is ramped and then drops as it saturates. Since the gap makes the inductance insensitive to the exact permeability of the core, you have to really zoom in on V(n001) to see that it does increase. The peak is when H inside the core is equal to its Hc.

\*

```
L1 N001 0 Hc=16. Bs=.44 Br=.10 A=0.0000251
+ Lm=0.0198 Lg=0.0006858 N=1000
I1 0 N001 PWL(0 0 1 1)
.tran .5
.options maxstep=10u
.end
```

## M. MOSFET

Symbol Names: NMOS, NMOS3, PMOS, PMOS3 There are two fundamentally different types of MOSFETS in LTspice, monolithic MOSFETs and a new vertical double diffused power MOSFET model.

Monolithic MOSFET:

```
Syntax: Mxxx Nd Ng Ns Nb <model> [m=<value>] [L=<len>]
+ [W=<width>] [AD=<area>] [AS=<area>]
+ [PD=<perim>] [PS=<perim>] [NRD=<value>]
+ [NRS=<value>] [off] [IC=<Vds, Vgs, Vbs>]
+ [temp=<T>]
```

```
M1 Nd Ng Ns 0 MyMOSFET
.model MyMOSFET NMOS(KP=.001)
```

```
M1 Nd Ng Ns Nb MypMOSFET
.model MypMOSFET PMOS(KP=.001)
```

Vertical double diffused power MOSFET:

```
Syntax: Mxxx Nd Ng Ns <model> [L=<len>] [W=<width>]
+ [M=<area>] [m=<value>] [off]
+ [IC=<Vds, Vgs, Vbs>] [temp=<T>]
```

Example:

```
M1 Nd Ng Ns Si4410DY
.model Si4410DY VDMOS(Rd=3m Rs=3m Vto=2.6 Kp=60
+ Cgdmax=1.9n Cgdmin=50p Cgs=3.1n Cjo=1n
+ Is=5.5p Rb=5.7m)
```

The MOSFET's model card specifies which type is intended. The model card keywords NMOS and PMOS specify a monolithic N- or P- channel MOSFET transistor. The model card keyword VDMOS specifies a vertical double diffused power MOSFET.

Monolithic MOSFETS are four terminal devices. Nd, Ng, NS, and Nb are the drain, gate, source, and bulk; i.e., substrate; nodes. L and W are the channel length and width, in meters. AD and AS are the areas of the drain and source diffusions, in square meters. Note that the suffix u specifies  $\mu\text{m}$  and p square  $\mu\text{m}$ . If any of L, W, AD, or AS are not specified, default values are used. PD and PS are the perimeters of the drain and source junctions, in meters. NRD and NRS designate the equivalent number of squares of the drain and source diffusions; these values multiply the sheet resistance RSH specified on the .MODEL control line. PD and PS default to zero while NRD and NRS to one. OFF indicates an initial condition on the device for DC analysis. The initial condition specification using IC=VDS, VGS, VBS is for use with the UIC option on the .TRAN control line, when a transient analysis is desired starting from other than the quiescent operating point. The optional TEMP value is the temperature at which

this device is to operate, and overrides the temperature specification on the .OPTION control line. The temperature specification is ONLY valid for level 1, 2, 3, and 6 MOSFETs, not for level 4, 5 or 8 BSIM devices.

LTspice contains seven different types of monolithic MOSFET's and one type of vertical double diffused Power MOSFET.

There are seven monolithic MOSFET device models. The model parameter LEVEL specifies the model to be used. The default level is one.

level	model
1	Shichman-Hodges
2	MOS2 (see A. Vladimirescu and S. Liu, The Simulation of MOS Integrated Circuits Using SPICE2, ERL Memo No. M80/7, Electronics Research Laboratory University of California, Berkeley, October 1980)
3	MOS3, a semi-empirical model (see reference for level 2)
4	BSIM (see B. J. Sheu, D. L. Scharfetter, and P. K. Ko, SPICE2 Implementation of BSIM. ERL Memo No. ERL M85/42, Electronics Research Laboratory University of California, Berkeley, May 1985)
5	BSIM2 (see Min-Chie Jeng, Design and Modeling of Deep-Submicrometer MOSFETs ERL Memo Nos. ERL M90/90, Electronics Research Laboratory University of California, Berkeley, October 1990)

- 6 MOS6 (see T. Sakurai and A. R. Newton, A Simple MOSFET Model for Circuit Analysis and its application to CMOS gate delay analysis and series-connected MOSFET Structure, ERL Memo No. ERL M90/19, Electronics Research Laboratory, University of California, Berkeley, March 1990)
  
- 8 BSIM3v3.3.0 from University of California, Berkeley as of July 29, 2005
  
- 9 BSIMSOI3.2 (Silicon on insulator) from the BSIM Research Group of the University of California, Berkeley, February 2004.
  
- 12 EKV 2.6 based on code from Ecole Polytechnique Federale de Lausanne. See <http://legwww.epfl.ch/ekv> and "The EPFL-EKV MOSFET Model Equations for Simulation, Version 2.6", M. Bucher, C. Lallement, F. Theodoloz, C. Enz, F. Krummenacher, EPFL-DE-LEG, June 1997.
  
- 14 BSIM4.6.1 from the University of California, Berkeley BSIM Research Group, May 18, 2007.

The DC characteristics of the level 1 through level 3 MOSFETs are defined by the device parameters VTO, KP, LAMBDA, PHI and GAMMA. These parameters are computed if the process parameters(NSUB, TOX,...) are given, but user-specified values always override. VTO is positive (negative) for enhancement mode and negative (positive) for depletion mode N-channel (P-channel) devices. Charge storage is modeled by three constant capacitors, CGSO, CGDO, and CGBO which represent overlap capacitances, by the non-linear thin-oxide capacitance which is distributed among the gate, source, drain, and bulk regions, and by the nonlinear depletion-layer capacitances for both substrate junctions divided into bottom and periphery, which vary as the MJ and MJSW power of junction voltage respectively, and are determined by the parameters CBD, CBS, CJ, CJSW, MJ, MJSW and PB. Charge storage effects are modeled by the piecewise linear voltages-dependent capacitance model proposed by Meyer. The thin-oxide charge-storage effects are

treated slightly different for the Level=1 model. These voltage dependent capacitances are included only if Tox is specified.

There is some overlap among the parameters describing the junctions, e.g., the reverse current can be specified either through Is[Amp] or through Js[Amp/m/m]. Whereas the first is an absolute value the second is multiplied by Ad and As to give the reverse current of the drain and source junctions respectively. The same idea applies also to the zero-bias junction capacitances CBD and CBS[Farad] on one hand, and CJ[Farad/m/m] on the other. The parasitic drain and source series resistance can be expressed as either RD and RS[Ohms] or RSH[Ohms/square], the latter being multiplied by the number of squares NRD and NRS input on the device line.

MOSFET level 1, 2, and 3 parameters:

<b>Name</b>	<b>Description</b>	<b>Units</b>	<b>Default</b>	<b>Example</b>
Vto	Zero-bias threshold voltage	V	0	1.0
Kp	Transconductance parameter	A/V <sup>2</sup>	2e-5	3e-5
Gama	Bulk threshold parameter	V <sup>1/2</sup>	0.	0.37
Phi	Surface inversion potential	V	0.6	0.65
Lambda	Channel-length modulation (level 1 and 2 only)	1/V	0.	0.02
Rd	Drain ohmic resistance	Ω	0.	1.
Rs	Source ohmic resistance	Ω	0.	1.
Cbd	Zero-bias B-D	F	0.	20f



	junction capacitance			
Cbs	Zero-bias B-S junction capacitance	F	0.	20f
Is	Bulk junction saturation current	A	1e-14	1e-15
N	Bulk diode emission coefficient	-	1.	
Pb	Bulk junction potential	V	0.8	0.87
Cgs <sub>o</sub>	Gate-source overlap capacitance per meter channel width	F/m	0.	4e-11
Cgd <sub>o</sub>	Gate-drain overlap capacitance per meter channel width	F/m	0.	4e-11
Cgb <sub>o</sub>	Gate-bulk overlap capacitance per meter channel width	F/m	0.	2e-10
Rsh	Drain and source diffusion sheet resistance	$\Omega$	0.	10.
Cj	Zero-bias bulk junction bottom capacitance per square meter of junction area	F/m <sup>2</sup>	0.	2e-4
Mj	Bulk junction bottom grading coefficient	-	0.5	0.5
Cjs <sub>w</sub>	Zero-bias bulk junction sidewall capacitance per meter of junction perimeter	F/m	0.	1p
Mjs	Bulk junction	-	.50 level 1	

w	sidewall grading coefficient		.33	level 2,3
Js	Bulk junction saturation current per square-meter of junction area	A/m	0.	1e-8
Tox	Oxide thickness	m	1e-7	1e-7
Nsub	Substrate doping	1/cm <sup>3</sup>	0.	4e15
Nss	Surface state density	1/cm <sup>2</sup>	0.	1e+10
Nfs	Fast surface state	1/cm <sup>2</sup>	0.	1e+10
TPG	Type of gate material:  +1 opp. to substrate  -1 same as substrate  0 Al gate	-	1	
Xj	Metallurgical junction depth	m	0.	1μ
Ld	Lateral diffusion	m	0.	0.8 μ
Uo	Surface mobility	cm <sup>2</sup> /V/s	600	700
Ucrit	Critical field for mobility degradation (level 2 only)	V/cm	1e4	1e4
Uexp	Critical field exponent in mobility degradation (level 2 only)	-	0.	0.1

Utr a	Transverse field coefficient (level 2 only)	-	0.	0.3
Vma x	Maximum carrier drift velocity (levels 2 & 3 only)	m/s	0.	5e4
Nef f	Total channel-charge exponent (level 2 only)	-	1.	5.
Kf	Flicker noise coefficient	-	0.	1e- 26
Af	Flicker noise exponent	-	1.	1.2
Fc	Coefficient for forward-bias depletion capacitance formula	-	0.5	
Del ta	Width effect on threshold voltage(levels 2 and 3)	-	0.	1.
The ta	Mobility modulation (level 3 only)	-	0.	0.1
Eta	Static feedback (level 3 only)	-	0.	1.
Kap pa	Saturation field (level 3 only)		0.2	0.5
Tno m	Parameter measurement temperature	°C	27	50

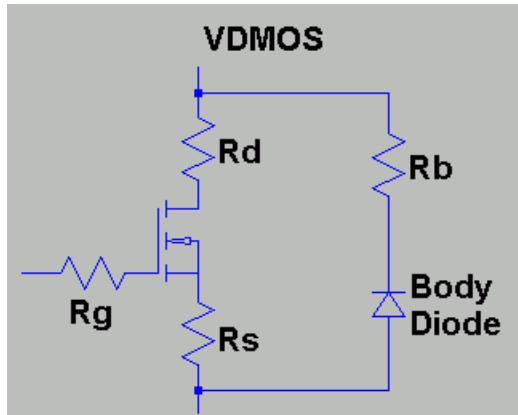

The discrete vertical double diffused MOSFET transistor (VDMOS) popularly used in board level switch mode power supplies has behavior that is qualitatively different than the above monolithic MOSFET models. In particular, (i) the body diode of a VDMOS transistor is connected differently to the external terminals than the substrate diode of a monolithic MOSFET and (ii) the gate-drain capacitance ( $C_{gd}$ ) non-linearity cannot be modeled with the simple graded capacitances of monolithic MOSFET models. In a VDMOS transistor,  $C_{gd}$  abruptly changes about zero gate-drain voltage ( $V_{gd}$ ). When  $V_{gd}$  is negative,  $C_{gd}$  is physically based a capacitor with the gate as one electrode and the drain on the back of the die as the other electrode. This capacitance is fairly low due to the thickness of the non-conducting die. But when  $V_{gd}$  is positive, the die is conducting and  $C_{gd}$  is physically based on a capacitor with the thickness of the gate oxide.

Traditionally, elaborate subcircuits have been used to duplicate the behavior of a power MOSFET. A new intrinsic spice device was written that encapsulates this behavior in the interest of compute speed, reliability of convergence, and simplicity of writing models. The DC model is the same as a level 1 monolithic MOSFET except that the length and width default to one so that transconductance can be directly specified without scaling. The AC model is as follows. The gate-source capacitance is taken as constant. This was empirically found to be a good approximation for power MOSFETS if the gate-source voltage is not driven negative. The gate-drain capacitance follows the following empirically found form:

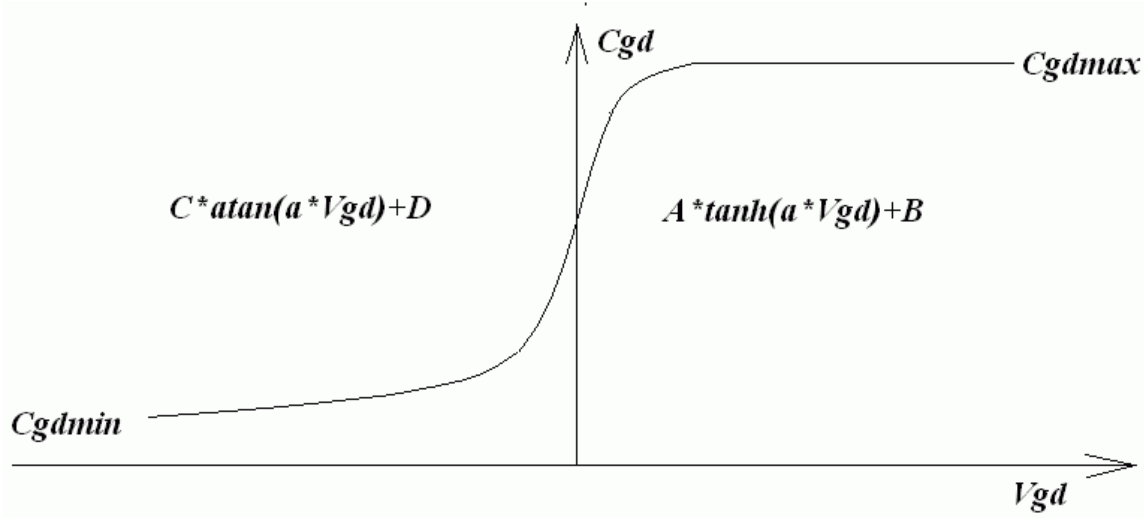

For positive  $V_{gd}$ ,  $C_{gd}$  varies as the hyperbolic tangent of  $V_{gd}$ . For negative  $V_{gd}$ ,  $C_{gd}$  varies as the arc tangent of  $V_{gd}$ . The model parameters  $a$ ,  $C_{gdmax}$ , and  $C_{gdmin}$  parameterize the gate drain capacitance. The source-drain capacitance is supplied by the graded capacitance of a body diode connected across the source drain electrodes, outside of the source and drain resistances.

Name	Description	Units	Default	Example
Vto	Threshold voltage	V	0	1.0
Kp	Transconductance parameter	A / V <sup>2</sup>	1.	.5
Phi	Surface inversion potential	V	0.6	0.65
Lambda da	Channel-length modulation	1 / V	0.	0.02
Rd	Drain ohmic resistance	Ω	0.	1.
Rs	Source ohmic resistance	Ω	0.	1.

	resistance			
Rg	Gate ohmic resistance	$\Omega$	0.	2.
Rds	Drain-source shunt resistance	$\Omega$	Inf in.	10Meg
Rb	Body diode ohmic resistance	$\Omega$	0.	.5
Cjo	Zero-bias body diode junction capacitance	F	0.	1n
Cgs	Gate-source capacitance	F	0.	500p
Cgdm in	Minimum non-linear G-D capacitance	F	0.	300p
Cgdm ax	Maximum non-linear G-D capacitance	F	0.	1000p
A	Non-linear Cgd capacitance parameter	-	1.	.5
Is	Body diode saturation current	A	1e-14	1e-15
N	Bulk diode emission coefficient	-	1.	
Vj	Body diode junction potential	V	1.	0.87
M	Body diode grading coefficient	-	0.5	0.5
Fc	Body diode coefficient for forward-bias depletion capacitance formula	-	0.5	
tt	Body diode transit time	sec	0.	10n
Eg	Body diode	e	1.1	

	activation energy for temperature effect on Is	V	1	
Xti	Body diode saturation current temperature exponent	-	3	
L	Length scaling	-	1.	
W	Width scaling	-	1.	
Kf	Flicker noise coefficient	-	0.	
Af	Flicker noise exponent	-	1.	
nchan[*]	N-channel VDMOS	-	(true)	-
pchan[*]	P-channel VDMOS	-	(false)	-
Tnom	Parameter measurement temperature	°C	27	50

\*]The model name VDMOS is used both for a N-channel and P-channel device. The polarity defaults to N-channel. To specify P-channel, flag the model with the keyword "pchan", e.g., ".model xyz VDMOS(Kp = 3 pchan)" defines a P-channel transistor.

## O. Lossy Transmission Line

Symbol Name: LTLIN

Syntax: Oxxx L+ L- R+ R- <model>

Example:

O1 in 0 out 0 MyLossyTline

```
.model MyLossyTline LTRA(len=1 R=10 L=1u C=10n)
```

This is a single-conductor lossy transmission line. N1 and N2 are the nodes at port 1. N3 and N4 are the nodes at port 2. A model card is required to define the electrical characteristics of this circuit element.

#### Model parameters for Lossy Transmission Lines

Name	Description	Units/Type	Default
R		$\Omega$ /unit len	0.
L		H/unit len	0.
G		1/ $\Omega$ /unit len	0.
C		F/unit len	0.
Len	Number of Unit Lengths	-	0.
Rel	Relative rate of change of derivative to set a breakpoint		1.
Abs	Absolute rate of change of derivative to set a breakpoint		1.
NoStepLimit	Don't limit time- step to less than line delay	(flag)	not set
NoControl	Don't attempt complex time-step	(flag)	not set



	control		
LinInterp	Use linear interpolation	(flag)	not set
MixedInterp	Use linear interpolation when quadratic seems to fail	(flag)	not set
CompactRel	Reltol for history compaction		RELTOL
CompactAbs	Abstol for history compaction		ABSTOL
TruncNr	Use Newton-Raphson method for time-step control	(flag)	not set
TruncDontCut	Don't limit time-step to keep impulse-response errors low	(flag)	not set

## Q. Bipolar transistor

Symbol Names: NPN, PNP, NPN2, PNP2

Syntax: Qxxx Collector Base Emitter [Substrate Node]  
+ model [area] [off] [IC=<Vbe, Vce>] [temp=<T>]

Example:

```
Q1 C B E MyNPNmodel
.model MyNPNmodel NPN(Bf=75)
```

Bipolar transistors require a model card to specify its characteristics. The model card keywords NPN and PNP indicate the polarity of the transistor. The area factor determines the number of equivalent parallel devices of a specified model.

The bipolar junction transistor model is an adaptation of the integral charge control model of Gummel and Poon. This modified Gummel-Poon model extends the original model to include several effects at high bias levels, quasi-saturation, and substrate conductivity. The model automatically simplifies to the Ebers-Moll model when certain parameters are not specified. The DC model is defined by the parameters  $I_s$ ,  $B_f$ ,  $N_f$ ,  $I_{se}$ ,  $I_{kf}$ , and  $N_e$  which determine the forward current gain characteristics,  $I_s$ ,  $B_r$ ,  $N_r$ ,  $I_{sc}$ ,  $I_{kr}$ , and  $N_c$  which determine the reverse current gain characteristics, and  $V_{af}$  and  $V_{ar}$  which determine the output conductance for forward and reverse regions. Three ohmic resistances  $R_b$ ,  $R_c$  and  $R_e$ , are included, where  $R_b$  can be high current dependent. Base charge storage is modeled by forward and reverse transit times,  $T_f$  and  $T_r$ , the forward transit time  $T_f$  being bias dependent if desired; and nonlinear depletion layer capacitances, which are determined by  $C_{je}$ ,  $V_{je}$  and  $M_{je}$ , for the B-E junction,  $C_{jc}$ ,  $V_{jc}$ , and  $M_{jc}$  for the B-C junction and  $C_{js}$ ,  $V_{js}$ , and  $M_{js}$  for the Collector-Substrate junction. The temperature dependence of the saturation current,  $I_s$ , is determined by the energy gap,  $E_g$ , and the saturation-current temperature exponent,  $X_{TI}$ . Additionally base current temperature dependence is modeled by the beta temperature exponent  $X_{TB}$  in the new model. The values specified are assumed to have been measured at the temperature  $T_{NOM}$ , which can be specified on the .OPTIONS control line or overridden by a specification on the .model line.

The BJT parameters used in the modified Gummel-Poon model are listed below.

#### Modified Gummel-Poon BJT Parameters

Name	Description	Un	Defa
------	-------------	----	------

		<b>its</b>	<b>ult</b>
Is	Transport saturation current	A	1e-16
Bf	Ideal maximum forward beta	-	100
Nf	Forward current emission coefficient	-	1.
Vaf	Forward Early voltage	V	Infin.
Ikf	Corner for forward beta high current roll-off	A	Infin.
Ise	B-E leakage saturation current	A	0.
Ne	B-E leakage emission coefficient	-	1.5
Br	Ideal maximum reverse beta	-	1.
Nr	Reverse current emission coefficient	-	1.
Var	Reverse Early voltage	V	Infin.
Ikr	Corner for reverse beta high current roll-off	A	Infin.
Isc	B-C leakage saturation current	A	0
Nc	B-C leakage emission coefficient	-	2
Rb	Zero-bias base resistance	$\Omega$	0
Irb	Current where base resistance falls halfway to its min value	A	Infin.
Rbm	Minimum base resistance at high currents	$\Omega$	Rb
Re	Emitter resistance	$\Omega$	0.
Rc	Collector resistance	$\Omega$	0.
Cje	B-E zero-bias depletion capacitance	F	0.
Vje	B-E built-in potential	V	0.75

Mje	B-E junction exponential factor	-	0.33
Tf	Ideal forward transit time	sec	0.
Xtf	Coefficient for bias dependence of Tf	-	0.
Vtf	Voltage describing Vbc dependence of Tf	V	Infin.
Itf	High-current parameter for effect on Tf	A	0.
Ptf	Excess phase at freq=1/(Tf*2*PI)Hz	°	0.
Cjc	B-C zero-bias depletion capacitance	F	0.
Vjc	B-C built-in potential	V	0.75
Mjc	B-C junction exponential factor	-	0.33
Xcjc	Fraction of B-C depletion capacitance connected to internal base node	-	1.
Tr	Ideal reverse transit time	sec	0.
Cjs	Zero-bias collector-substrate capacitance	F	0.
Vjs	Substrate junction built-in potential	V	0.75
Mjs	Substrate junction exponential factor	-	0.
Xtb	Forward and reverse beta temperature exponent	-	0.
Eg	Energy gap for temperature effect on Is	eV	1.11
Xti	Temperature exponent for effect on Is	-	3.
Kf	Flicker-noise coefficient	-	0.
Af	Flicker-noise exponent	-	1.

Fc	Coefficient for forward-bias depletion capacitance formula	-	0.5
Tnom	Parameter measurement temperature	°C	27
Cn	Quasi-saturation temperature coefficient for hole mobility	2.42 NPN 2.2 PNP	
D	Quasi-saturation temperature coefficient for scattering-limited hole carrier velocity	.87 NPN .52 PNP	
Gamm a	Epitaxial region doping factor		1e-1 1
Qco	Epitaxial region charge factor	Co ul	0.
Quas imod	Quasi-saturation flag for temperature dependence	-	(not set)
Rco	Epitaxial region resistance	Ω	0.
Vg	Quasi-saturation extrapolated bandgap voltage at 0°K	V	1.20 6
Vo	Carrier mobility knee voltage	V	10.
Trel	Re linear temperature coefficient	1/ °C	0.
Tre2	Re quadratic temperature coefficient	1/ °C 2	0.
Trb1	Rb linear temperature coefficient	1/ °C	0.
Trb2	Rb quadratic temperature coefficient	1/ °C 2	0.
Trc1	Rc linear temperature coefficient	1/ °C	0.
Trc2	Rc quadratic temperature coefficient	1/ °C 2	0.

Trm1	Rmb linear temperature coefficient	1/ °C	0.
Trm2	Rmb quadratic temperature coefficient	1/ °C <sup>2</sup>	0.
Iss	Substrate junction saturation current	A	0.
Ns	Substrate junction emission Coefficient	-	1.

The model parameter "level" can be used to specify another type of BJT in LTspice. Due to a generous contribution of source code from Dr.-Ing. Dietmar Warning of DAnalyse GmbH, Berlin, Germany; LTspice includes a version of VBIC. Set Level=9 to use the alternate device. Level 4 is a synonym for level 9. The following documentation has been supplied by Dr. Warning:

#### VBIC - Vertical Bipolar Inter Company model

The VBIC model is an extended development of the Standard Gummel-Poon (SGP) model with the focus of integrated bipolar transistors in today's modern semiconductor technologies. With the implemented modified Quasi-Saturation model from Kull and Nagel it is also possible to model the special output characteristic of switching transistors. It is a widely used alternative to the SGP model for silicon, SiGe and III-V HBT devices.

#### VBIC Capabilities compared to Standard Gummel-Poon Model

- o Integrated Substrate transistor for parasitic devices in integrated processes
- o Weak avalanche and Base-emitter breakdown model
- o Improved Early Effect modeling
- o Physical separation of  $I_c$  and  $I_b$
- o Improved Depletion capacitance model
- o Improved temperature modeling
- o Self-heating modeling (not in this version)

#### Model Structure

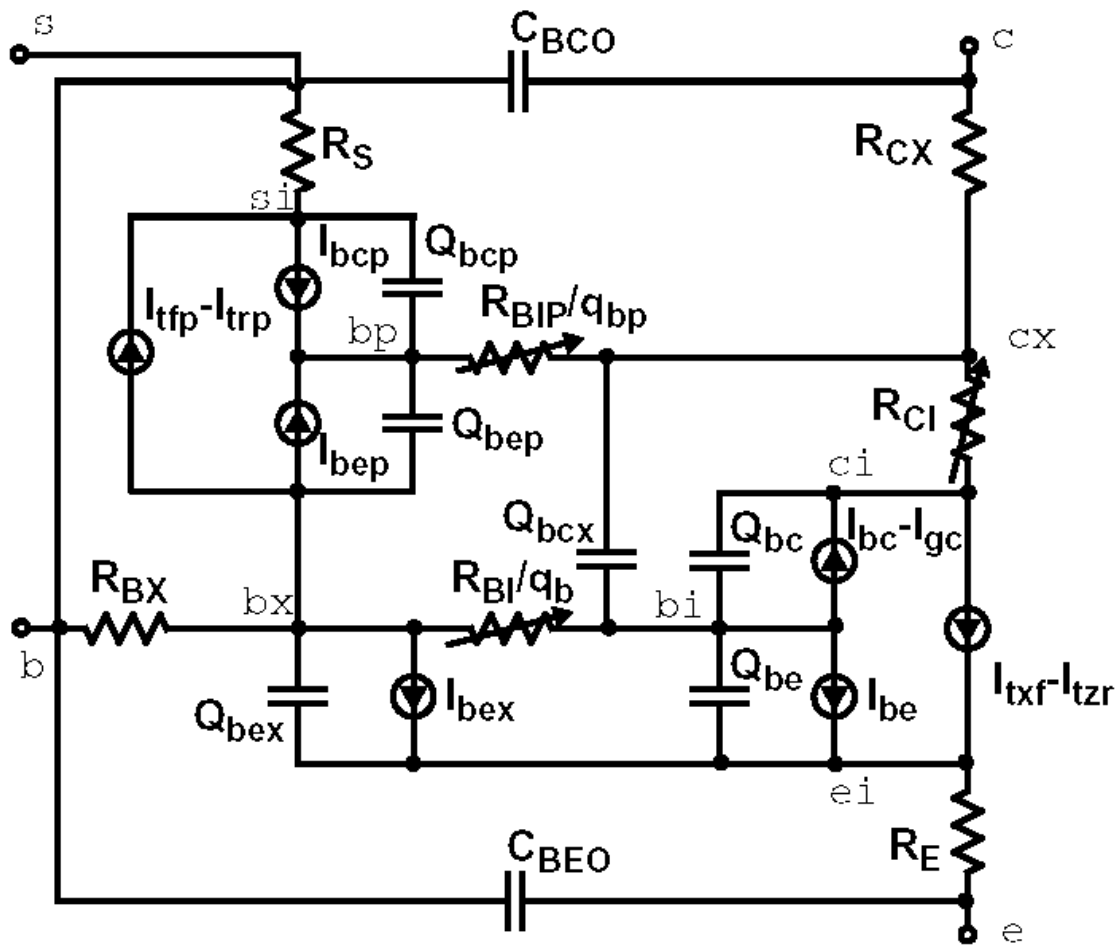

### Parameters

Because the VBIC model is based on SGP model it is possible to start with SGP parameters, carry out some transformations. Following parameters are from VBIC version 1.2, which is implemented in LTSpice in the 4-terminal version without excess phase network and self-heating effect. To switch from SGP to VBIC you should set the extra parameter **level** to 9.

Na me	Parameter meaning	Uni t	Defau lt
tn om	Parameter measurement temperature	°C	27.
rc x	Extrinsic coll resistance	Ω	0.1

rc i	Intrinsic coll resistance	$\Omega$	0.1
vo	Epi drift saturation voltage	V	Infin .
ga mm	Epi doping parameter		0.0
hr cf	High current RC factor		Infin .
rb x	Extrinsic base resistance	$\Omega$	0.1
rb i	Intrinsic base resistance	$\Omega$	0.1
re	Intrinsic emitter resistance	$\Omega$	0.1
rs	Intrinsic substrate resistance	$\Omega$	0.1
rb p	Parasitic base resistance	$\Omega$	0.1
is	Transport saturation current	A	1e-16
nf	Forward emission coefficient		1.
nr	Reverse emission coefficient		1.
fc	Fwd bias depletion capacitance limit		0.9
cb eo	Extrinsic B-E overlap capacitance	F	0.0
cj e	Zero bias B-E depletion capacitance	F	0.0
pe	B-E built in potential	V	0.75
me	B-E junction grading coefficient		0.33
aj	B-E capacitance smoothing		-0.5



e	factor		
cb co	Extrinsic B-C overlap capacitance	F	0.
cj c	Zero bias B-C depletion capacitance	F	0.
qc o	Epi charge parameter	C	0.
cj ep	B-C extrinsic zero bias capacitance	F	0.
pc	B-C built in potential	V	0.75
mc	B-C junction grading coefficient		0.33
aj c	B-C capacitance smoothing factor		-0.5
cj cp	Zero bias S-C capacitance	F	0.
ps	S-C junction built in potential	V	0.75
ms	S-C junction grading coefficient		0.33
aj s	S-C capacitance smoothing factor		-0.5
ib ei	Ideal B-E saturation current	A	1e-18
wb e	Portion of IBEI from Vbei 1-WBE from Vbex		1.
ne i	Ideal B-E emission coefficient		1.
ib en	Non-ideal B-E saturation current	A	0.
ne n	Non-ideal B-E emission coefficient		2.
ib ci	Ideal B-C saturation current	A	1e-16

nc i	Ideal B-C emission coefficient		1.
ib cn	Non-ideal B-C saturation current	A	0.
nc n	Non-ideal B-C emission coefficient		1.
av c1	B-C weak avalanche parameter 1	1/V	0.
av c2	B-C weak avalanche parameter 2	1/V	0.
is p	Parasitic transport saturation current	A	0.
ws p	Portion of ICCP		1.
nf p	Parasitic fwd emission coefficient		1.
ib ei p	Ideal parasitic B-E saturation current	A	0.
ib en p	Non-ideal parasitic B-E saturation current	A	0.
ib ci p	Ideal parasitic B-C saturation current	A	0.
nc ip	Ideal parasitic B-C emission coefficient		1.
ib cn p	Non-ideal parasitic B-C saturation current	A	0.
nc np	Non-ideal parasitic B-C emission coefficient		2.
ve f	Forward Early voltage		Infin .
ve	Reverse Early voltage		Infin

r			.
ik f	Forward knee current	A	Infin .
ik r	Reverse knee current	A	Infin .
ik p	Parasitic knee current	A	Infin .
tf	Ideal forward transit time	s	0.
qt f	Variation of TF with base-width modulation		0.
xt f	Coefficient for bias dependence of TF		0.
vt f	Voltage giving VBC dependence of TF	V	Infin .
it f	High current dependence of TF	A	Infin .
tr	Ideal reverse transit time	sec	0.
td	Forward excess-phase delay time	Sec	0.
kf n	B-E Flicker Noise Coefficient		0.
af n	B-E Flicker Noise Exponent		1.
bf n	B-E Flicker Noise 1/f dependence		1.0
xr e	Temperature exponent of RE		0.
xr bi	Temperature exponent of RBI		0.
xr ci	Temperature exponent of RCI		0.
xr s	Temperature exponent of RS		0.
xv	Temperature exponent of VO		0.

o			
ea	Activation energy for IS	V	1.12
ea ie	Activation energy for IBEI	V	1.12
ea ic	Activation energy for IBCI/IBEIP	V	1.12
ea is	Activation energy for IBCIP	V	1.12
ea ne	Activation energy for IBEN	V	1.12
ea nc	Activation energy for IBCN/IBENP	V	1.12
ea ns	Activation energy for IBCNP	V	1.12
xi s	Temperature exponent of IS		3.
xi i	Temperature exponent of IBEI, IBCI, IBEIP, IBCIP		3.
xi n	Temperature exponent of IBEN, IBCN, IBENP, IBCNP		3.
tn f	Temperature exponent of NF		0.
ta vc	Temperature exponent of AVC2		0.
rt h	Thermal resistance	K/W	0.
ct h	Thermal capacitance	Ws/ K	0.
vr t	Punch-through voltage of internal B-C junction	V	0.
ar t	Smoothing parameter for reach-through		0.1
cc so	Fixed C-S capacitance	F	0.

qb m	Select SGP qb formulation		0.
nk f	High current beta rolloff		0.5
xi kf	Temperature exponent of IKF		0.
xr cx	Temperature exponent of RCX		0.
xr bx	Temperature exponent of RBX		0.
xr bp	Temperature exponent of RBP		0.
is rr	Separate IS for fwd and rev		1.
xi sr	Temperature exponent of ISR		0.
de ar	Delta activation energy for ISRR		0.
ea p	Excitation energy for ISP		1.12
vb be	B-E breakdown voltage	V	0.
nb be	B-E breakdown emission coefficient		1.
ib be	B-E breakdown current		1e-06
tv bb e1	Linear temperature coefficient of VBBE		0.
tv bb e2	Quadratic temperature coefficient of VBBE		0.
tn bb e	Temperature coefficient of NBBE		0.

eb be	$\exp(-V_{BBE}/(N_{BBE} \cdot V_{tv}))$		0.
dt em p	Locale Temperature difference	°	0.
ve rs	Revision Version		1.2
vr ef	Reference Version		0.

### References:

C. C. McAndrew et al., "Vertical Bipolar Inter Company 1995: An Improved Vertical, IC Bipolar Transistor Model", Proceedings of the IEEE Bipolar Circuits and Technology Meeting, pp. 170 – 177, 1995

C. C. McAndrew et.al., VBIC95, "The Vertical Bipolar Inter-Company Model", IEEE Journal of Solid State Circuits, vol. 31, No. 10, October 1996

C. C. McAndrew, VBIC Model Definition, Release 1.2, 18. Sep. 1999

## R. Resistor

Symbol Names: RES, RES2

Syntax: Rxxx n1 n2 <value> [tc=tc1, tc2, ...]  
+ [temp=<value>]

The resistor supplies a simple linear resistance between nodes n1 and n2. A temperature dependence can be defined for each resistor instance with the parameter tc. The resistance, R, at will be

$$R = R_0 * (1. + dt * tc_1 + dt^{**2} * tc_2 + dt^{**3} * tc_3 + \dots)$$

where R0 is the resistance at the nominal temperature and dt is the difference between the resistor's temperature and the nominal temperature.

## S. Voltage Controlled Switch

Symbol Names: SW

Syntax: Sxxx n1 n2 nc+ nc- <model> [on,off]

Example:

```
S1 out 0 in 0 MySwitch
```

```
.model MySwitch SW(Ron=.1 Roff=1Meg Vt=0 Vh=-.5 Lser=10n  
Vser=.6)
```

The voltage between nodes nc+ and nc- controls the switch's impedance between nodes n1 and n2. A model card is required to define the behavior of the switch. See the schematic file `.\examples\Educational\Vswitch.asc` to see an example of a model card placed directly on a schematic as a SPICE directive.

### Voltage Controlled Switch Model Parameters

<b>Na me</b>	<b>Description</b>	<b>Un it s</b>	<b>Defa ult</b>
Vt	Threshold voltage	V	0.
Vh	Hysteresis voltage	V	0.
Ro n	On resistance	$\Omega$	1.
Ro ff	Off resistance	$\Omega$	1/Gm in
Ls er	Series inductance	H	0.

Vs er	Series voltage	V	0.
I l i m i t	Current limit	A	Infi n.

The switch has three distinct modes of voltage control, depending on the value of the hysteresis voltage,  $V_h$ . If  $V_h$  is zero, the switch is always completely on or off depending upon whether the input voltage is above the threshold. If  $V_h$  is positive, the switch shows hysteresis, as if it was controlled by a Schmitt trigger with trip points at  $V_t - V_h$  and  $V_t + V_h$ . Note that  $V_h$  is half the voltage between trip points which is different than the common laboratory nomenclature. If  $V_h$  is negative, the switch will smoothly transition between the on and off impedances. The transition occurs between the control voltages of  $V_t - V_h$  and  $V_t + V_h$ . The smooth transition follows a low order polynomial fit to the logarithm of the switch's conduction.

There is also a level 2 voltage-controlled switch which is an advanced version of the level 1 switch with negative hysteresis. The level 2 switch is never completely on or off. The conduction as a function of control voltage  $V_c$  is

$$g(V_c) = \exp(A * \text{atan}((V_c - V_t)/\text{abs}(V_h)) + B)$$

where

$$A = \log(R_{\text{off}} / R_{\text{on}}) / \pi$$

$$B = \log(1 / (R_{\text{off}} * R_{\text{on}})) / 2$$

Also, the transition of the level 2 switch to current limit is gradual instead of abrupt. At a fixed control voltage, the I-V curve is giving by the equation



$$I(V) = I_{\text{limit}} * \tanh(g(V_c) * V)$$

where  $I_{\text{limit}}$  defaults to 10 amperes for the level 2 switch.

The level 2 switch supports the option to conduct in only one direction by either specifying the flag "oneway" or specifying a voltage drop with parameter  $V_{\text{ser}}$ . The transition between forward conduction and reverse open circuit can be specified to be a smooth transition by specifying the parameter  $\epsilon$  to be non-zero.

## T. Lossless Transmission Line

Symbol Name: TLINE

Syntax: Txxx L+ L- R+ R- Zo=<value> Td=<value>

L+ and L- are the nodes at one port. R+ and R- are the nodes for the other port. Zo is the characteristic impedance. The length of the line is given by the propagation delay Td.

This element models only one propagation mode. If all four nodes are distinct in the actual circuit, then two modes may be excited. To simulate such a situation, two transmission-line elements are required.

## U. Uniform RC-line

Symbol Names: URC

Syntax: Uxxx N1 N2 Ncom <model> L=<len> [N=<lumps>]

N1 and N2 are the two element nodes the RC line connects, whereas Ncom is the node to which the capacitances are connected. MNAME

is the model name and LEN is the length of the RC line in meters. Lumps, if specified, is the number of lumped segments to use in modeling the RC line. A guess at an appropriate number of lumps to use will be made if lumps is not specified.

The URC model is derived from a model proposed by L. Gertzberg in 1974. The model is accomplished by a subcircuit-type expansion of the URC line into a network of lumped RC segments with internally generated nodes. The RC segments are in a geometric progression, increasing toward the middle of the URC line, with K as a proportionality constant.

The URC line is made up strictly of resistor and capacitor segments unless the ISPERL parameter is given a nonzero value, in which case the capacitors are replaced with reverse-biased diodes with a zero-bias junction capacitance equivalent to the capacitance replaced, and with a saturation current of ISPERL amps per meter of transmission line and an optional series resistance equivalent to RSPERL ohms per meter.

<b>Na me</b>	<b>Description</b>	<b>Un it s</b>	<b>Defa ult</b>
K	Propagation Constant	-	2.
Fm ax	Maximum Frequency of interest	Hz	1G
Rp er l	Resistance per unit length	$\Omega$	1K
Cp er l	Capacitance per unit length	F	1e-15
Is pe rl	Saturation Current per unit length	A	0.
Rs pe rl	Diode Resistance per unit length	$\Omega$	0.

## V. Voltage Source

Symbol Names: VOLTAGE, BATTERY

Syntax: Vxxx n+ n- <voltage> [AC=<amplitude>]  
+ [Rser=<value>] [Cpar=<value>]

This element sources a constant voltage between nodes n+ and n-. For AC analysis, the value of AC is used as the amplitude of the source at the analysis frequency. A series resistance and parallel capacitance can be defined. The equivalent circuit is:

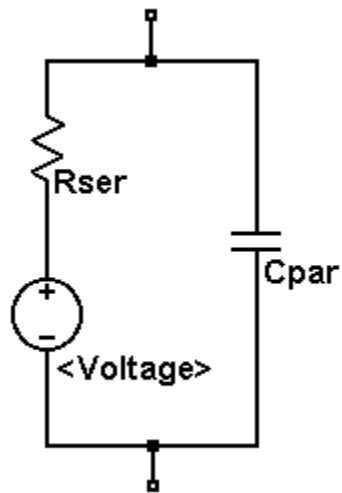

Voltage sources have historically been used as the current meters in SPICE and are used as current sensors for current-controlled elements. If Rser is specified, the voltage source can not be used as a sense element for F, H, or W elements. However, the current of any circuit element, including the voltage source, can be plotted.

Syntax: Vxxx n+ n- PULSE(V1 V2 Tdelay Trise Tfall Ton Tperiod Ncycles )

Time-dependent pulsed voltage source

<b>Nam e</b>	<b>Description</b>	<b>Un it s</b>
Vof f	Initial value	V
Von	Pulsed value	V
Tde lay	Delay	se c
Tr	Rise time	se c
Tf	Fall time	se c
Ton	On time	se c
Tpe rio d	Period	se c
Ncy cle s	Number of cycles(Omit for free-running pulse function)	cy cl es

Syntax: Vxxx n+ n- SINE(Voffset Vamp Freq Td Theta Phi Ncycles)

Time-dependent sine wave voltage source.

<b>Nam e</b>	<b>Description</b>	<b>Uni ts</b>
Vof fse	DC offset	V

t		
Vamp	Amplitude	V
p		
Fre	Frequency	Hz
q		
Td	Delay	sec
The	Damping factor	1/s
ta		ec
Phi	Phase of sine wave	deg
		ree
		s
Ncyc	Number of cycles(Omit	cyc
cle	for free-running pulse	les
s	function)	

For times less than Td or times after completing Ncycles, have run, the output voltage is given by

$$V_{offset} + V_{amp} \sin(\pi * \Phi / 180)$$

Otherwise the voltage is given by

$$V_{offset} + V_{amp} \exp(-(time - T_d) * \Theta) \sin(2 * \pi * Freq * (time - T_d) + \pi * \Phi / 180)$$

The damping factor, Theta, is the reciprocal of the decay time constant.

Syntax: Vxxx n+ n- EXP(V1 V2 Td1 Tau1 Td2 Tau2)

Time-dependent exponential voltage source

<b>Nam e</b>	<b>Description</b>	<b>Un it s</b>
V1	Initial value	V
V2	Pulsed value	V

Td1	Rise delay time	sec
		c
Tau 1	Rise-time constant	sec
		c
Td2	Fall delay time	sec
		c
Tau 2	Fall-time constant	sec
		c

For times less than Td1, the output voltage is V1. For times between Td1 and Td2 the voltage is given by

$$V1+(V2-V1)*(1-\exp(-(time-Td1)/Tau1)).$$

For times after Td2 the voltage is given by

$$V1+(V2-V1)*(1-\exp(-(time-Td1)/Tau1)) \\ +(V1-V2)*(1-\exp(-(time-Td2)/Tau2)).$$

Syntax: Vxxx n+ n- SFFM(Voff Vamp Fcar MDI Fsig)

Time-dependent single frequency FM voltage source.

<b>Nam e</b>	<b>Description</b>	<b>Un it s</b>
Vof f	DC offset	V
Vam p	Amplitude	V
Fca r	Carrier frequency	Hz

MDI	Modulation index	-
Fsig	Signal frequency	Hz
g		

The voltage is given by

$$V_{off} + V_{amp} * \sin((2 * \pi * F_{car} * time) + MDI * \sin(2 * \pi * F_{sig} * time))$$

Syntax: Vxxx n+ n- PWL(t1 v1 t2 v2 t3 v3...)

Arbitrary Piece-wise linear voltage source.

For times before t1, the voltage is v1. For times between t1 and t2, the voltage varies linearly between v1 and v2. There can be any number of time, voltage points given. For times after the last time, the voltage is the last voltage.

Syntax: Vxxx n+ n- wavfile=<filename> [chan=<nnn>]

This allows a .wav file to be used as an input to LTspice. <filename> is either a full, absolute path for the .wav file or a relative path computed from the directory containing the simulation schematic or netlist. Double quotes may be used to specify a path containing spaces. The .wav file may contain up to 65536 channels, numbered 0 to 65535. Chan may be set to specify which channel is used. By default, the first channel, number 0, is used. The .wav file is interpreted as having a full scale range from -1V to 1V.

This source only has meaning in a .tran analysis.

## W. Current Controlled Switch

Symbol Names: CSW

Syntax: Wxxx n1 n2 Vnam <model> [on,off]

Example:

```
W1 out 0 Vsense MySwitch
```

```
Vsense a b 0.
```

```
.model MySwitch CSW(Ron=.1 Roff=1Meg It=0 Ih=-.5)
```

The current through the named voltage source controls the switch's impedance. A model card is required to define the behavior of the current controlled switch.

#### Current Controlled Switch Model Parameters

<b>Na me</b>	<b>Description</b>	<b>Un it s</b>	<b>Defaul t</b>
It	Threshold current	A	0.
Ih	Hysteresis current	A	0.
Ro n	On resistance	$\Omega$	1.
Ro ff	Off resistance	$\Omega$	1/Gmin

The switch has three distinct modes of current control, depending on the value of the hysteresis current,  $I_h$ . If  $I_h$  is zero, the switch is always completely on or off according to whether the control current is above threshold. If  $I_h$  is positive, the switch shows hysteresis with trip point currents at  $I_t - I_h$  and  $I_t + I_h$ . If  $I_h$  is negative, the switch will smoothly transition between the on and off impedances. The transition occurs between the control currents of  $I_t - I_h$  and  $I_t + I_h$ . The



smooth transition follows a low order polynomial fit to the logarithm of the switch's conduction.

## X. Subcircuit

Syntax: `Xxxx n1 n2 n3... <subckt name>`  
[<parameter>=<expression>]

Subcircuits allow circuitry to be defined and stored in a library for later retrieval by name. Below is an example of defining and calling a voltage divider and invoking it in a circuit.

```
* calling a subcircuit
*
* This is the circuit
X1 in out 0 divider top=9K bot=1K
V1 in 0 pulse(0 1 0 .5m .5m 0 1m)

* This is the subcircuit
.subckt divider A B C
R1 A B {top}
R2 B C {bot}
.ends divider
.tran 3m
.end
```

## Z. MESFET transistor

Symbol Names: MESFET

Syntax: `Zxxx D G S model [area] [off] [IC=<Vds, Vgs>]`  
+ `[temp=<value>]`

A MESFET transistor requires a model card to specify its characteristics. The model card keywords NMF and PMF specify the polarity of the transistor. The MESFET model is derived from the GaAs FET model described in H. Statz et al., GaAs FET Device and Circuit Simulation in SPICE, IEEE Transactions on Electron Devices, V34, Number 2, February, 1987 pp160-169.

Two ohmic resistances,  $R_d$  and  $R_s$ , are included. Charge storage is modeled by total gate charge as a function of gate-drain and gate-source voltages and is defined by the parameters  $C_{gs}$ ,  $C_{gd}$ , and  $P_b$ .

<b>Na me</b>	<b>Description</b>	<b>Un it s</b>	<b>Defa ult</b>
Vt o	Pinch-off voltage	V	-2.
Be ta	Transconductance parameter	A/ V <sup>2</sup>	1e-4
B	Doping tail extending parameter	1/ V	0.3
Al ph a	Saturation voltage parameter	1/ V	2.
La md a	Channel-length modulation	1/ V	0.
Rd	Drain ohmic resistance	$\Omega$	0.
Rs	Source ohmic resistance	$\Omega$	0.
Cg s	Zero-bias G-S junction capacitance	F	0.
Cg d	Zero-bias G-D junction capacitance	F	0.
Pb	Gate junction potential	V	1.
Kf	Flicker noise coefficient	-	0.
Af	Flicker noise exponent	-	1.
Fc	Forward-bias depletion coefficient	-	0.5

# Control Panel

## Accessing the Control Panel

To get to the Control Panel, use the menu command Tools=>Control Panel. There you can configure many aspects of LTspice IV.

## Compression

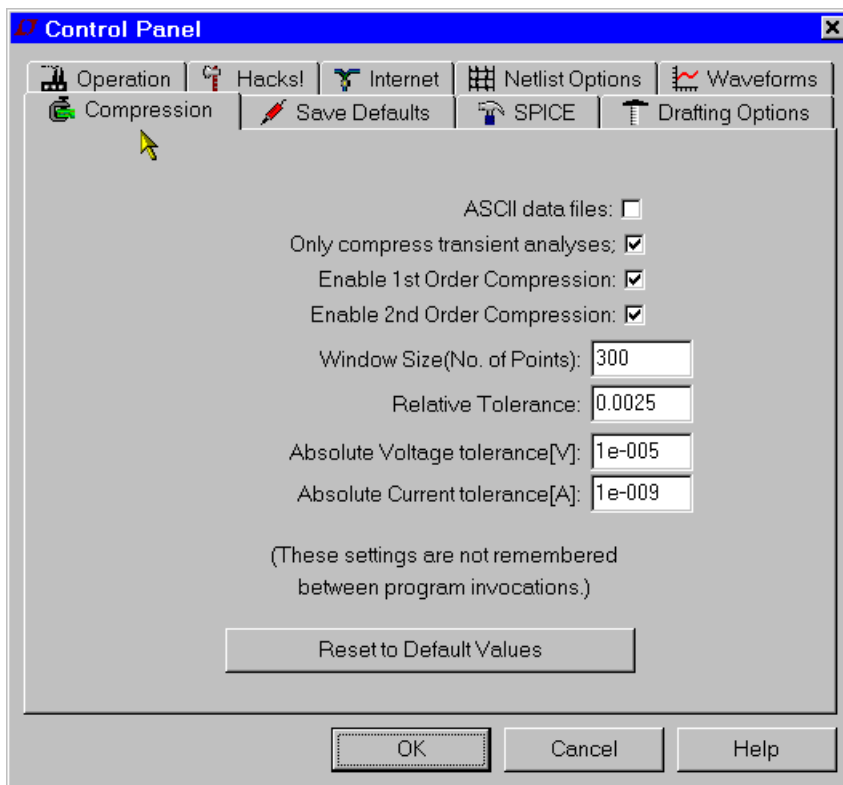

LTspice compresses the raw data files as they are generated. A compressed file can be 50 times smaller than the un-compressed one. This is a lossy compression. This pane of the control panel allows you to control how lossy the compression runs.

**Window Size(No. of Points):** Maximum number of points that can be compressed into two end points.

**Relative Tolerance:** The relative error allowed between the compressed data and the uncompressed data.

**Absolute Voltage tolerance[V]:** The voltage error allowed by the compression algorithm.

**Absolute Current tolerance[A]:** The current error allowed by the compression algorithm.

These compression settings are not remembered between program invocations to encourage use of the defaults. They are available on the control panel for diagnostic purposes. The tolerances and window size can be specified with option parameters `plotreltol`, `plotvntol`, `plotabstol` and `plotwinsize` in `.option` statements placed as SPICE directives on the schematic.

File Size Vs Fidelity study:

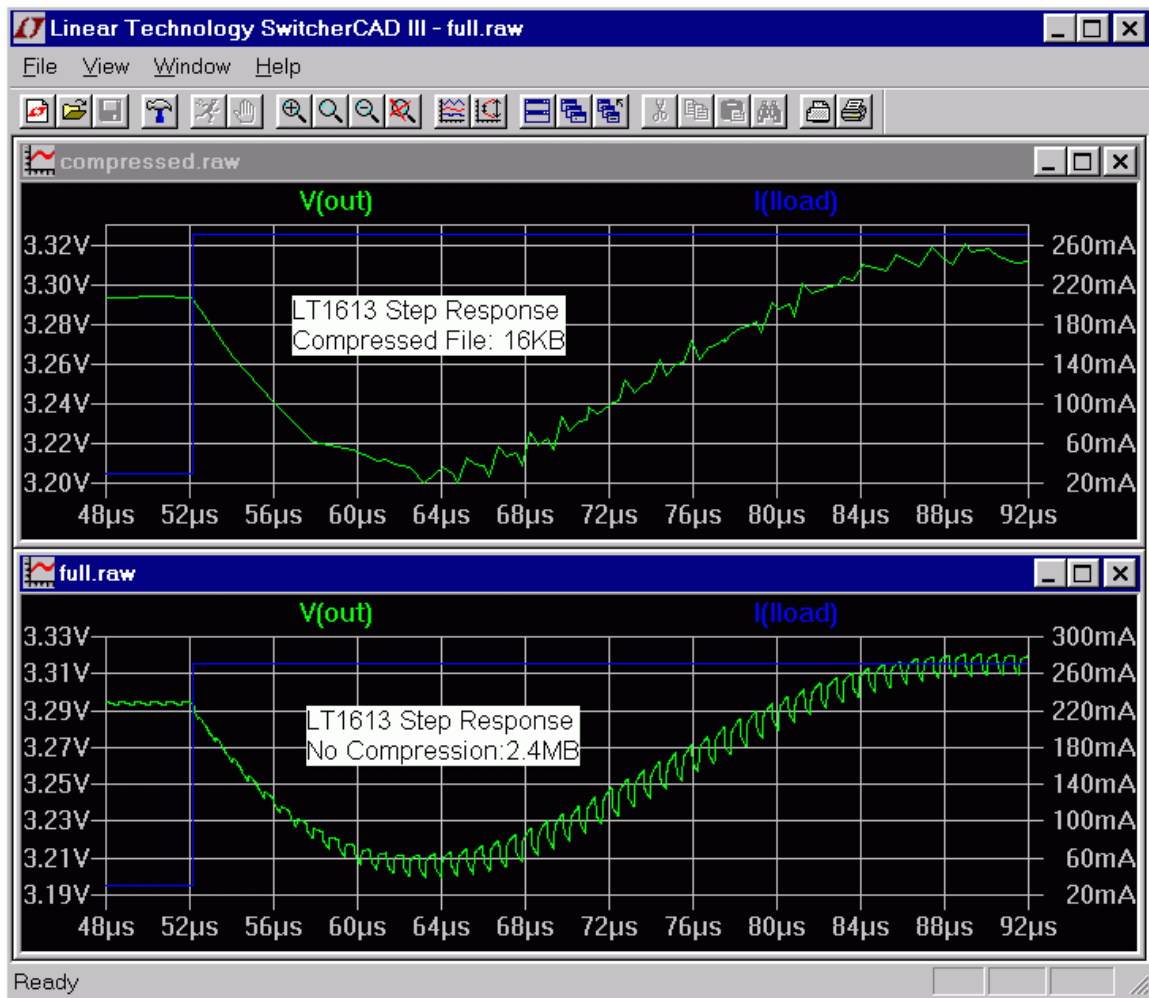

## Operation

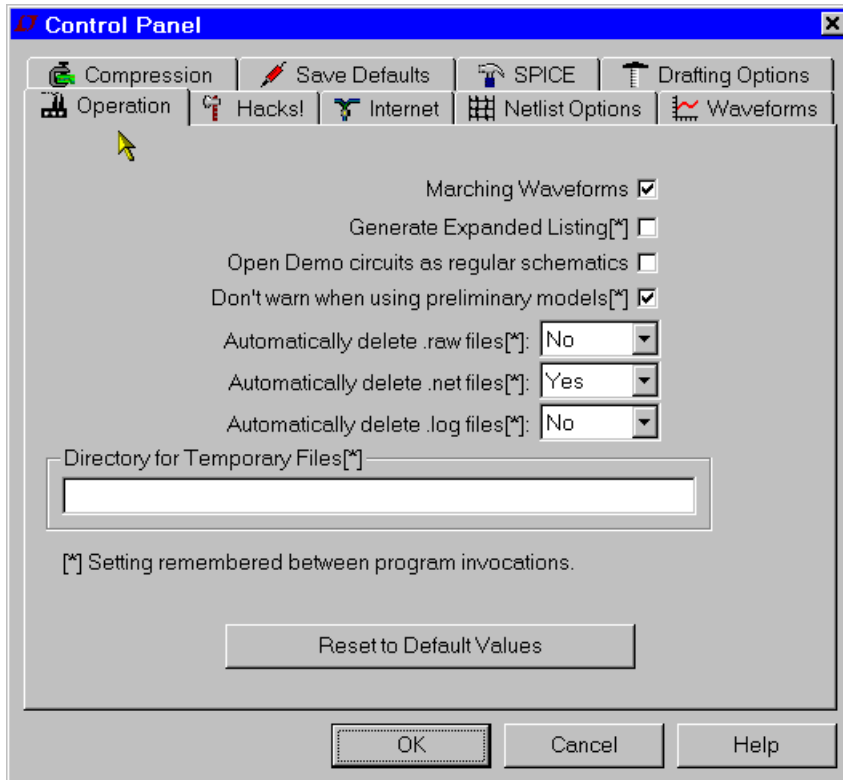

Settings marked with an asterisk [\*] are remembered between program invocations.

**Marching Waveforms:** Check to enable simulation results to be incrementally plotted during the simulation.

**Generate Expanded Listing:** Dump the flat netlist after expanding subcircuits to the in the [SPICE Error Log](#) file.

**Open Demo circuits as regular schematics:** Use [File] [Open] to open demo circuits in `.\LTspiceIV\lib\app\*.app`. All SPICE commands will be visible. The schematic can be edited and saved to a new file. The double dots `'..'` is for demo circuit display control use. Only one dot is required for editing.

**Don't warn when using preliminary models:** Turn off the warning message for all preliminary models. Note: All SMPS models are flagged as preliminary as a disclaimer.

**Automatically delete .raw files:** This allows waveform data files to be deleted automatically after closing a simulation. This dramatically reduces the amount of disk space used by LTspice but requires the simulation to be rerun when you reopen the simulation.

**Automatically delete .net files:** This allows the schematic's netlist to be automatically deleted whenever the schematic is closed. These files can be thought of as small temporary files and deleting them makes exploring the directory tidier. They define the electrical connectivity of the schematic to the LTspice simulator. Some people prefer not to delete them because they have further use for them.

**Automatically delete .log files:** This allows the simulation log to be automatically deleted whenever the simulation is closed. These files contain various simulation statistics such as elapsed time during the simulation, warning and error messages, and step parameters used for .step/.temp/.dc analyses.

**Directory for Temporary Files:** Directory for temporary storage of waveform and update files.

## Save Defaults

These settings are used when you don't explicitly state which nodes should be saved in a simulation. Useful settings are "Save Device Currents", "Save Subcircuit Node Voltages", and "Save Subcircuit Device Currents". Device voltages and internal device voltages are only of internal program development use.

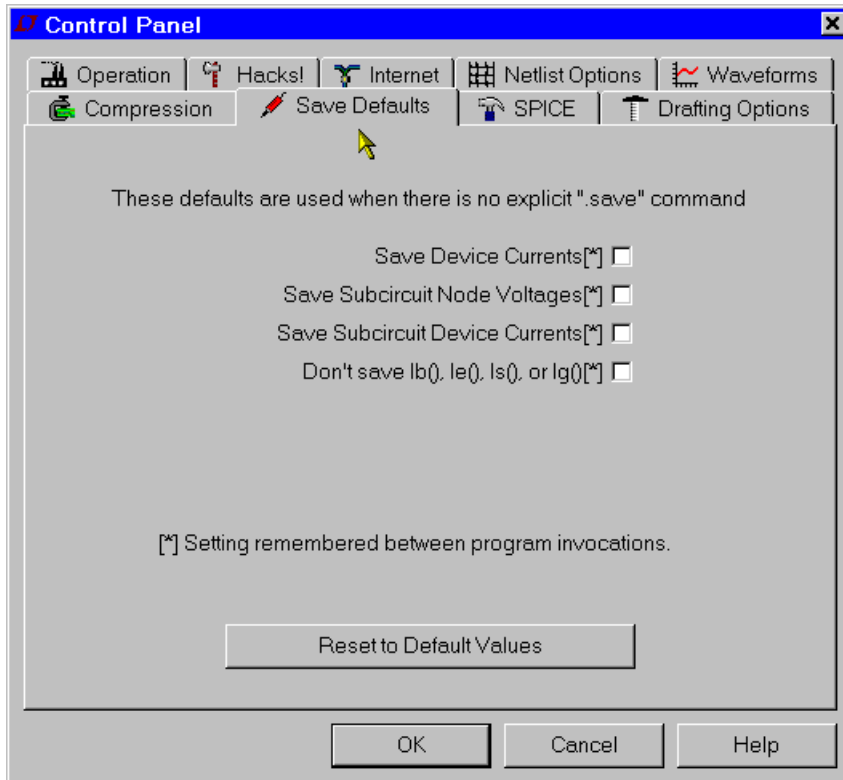

**Save Device Currents:** Check this so that you can plot device and terminal currents. You will also need it to be able to plot dissipation.

**Save Subcircuit Node Voltages:** You will need to check this to plot voltages in hierarchical designs.

**Save Subcircuit Device Currents:** You will need to check this to plot currents in hierarchical designs.

**Don't save Ib(), Ie(), Is(), Ig():** This saves only the collector(drain) currents of transistors in the interest of reducing the size of the output .data file. This is useful for IC design, but it using it means that there isn't enough data available to compute transistor dissipation.



**Save Device Currents:** Check this so that you can plot device and terminal currents. You will also need it to be able to plot dissipation.

## SPICE

This pane allows you to define the various defaults for LTSpice. These defaults can be overridden in any simulation by specifying the options in that simulation. Usually you can leave these options as they are. If you have frequently updated the program over the web, you might want to press "Reset to Default Values" to reset to the current recommended settings.

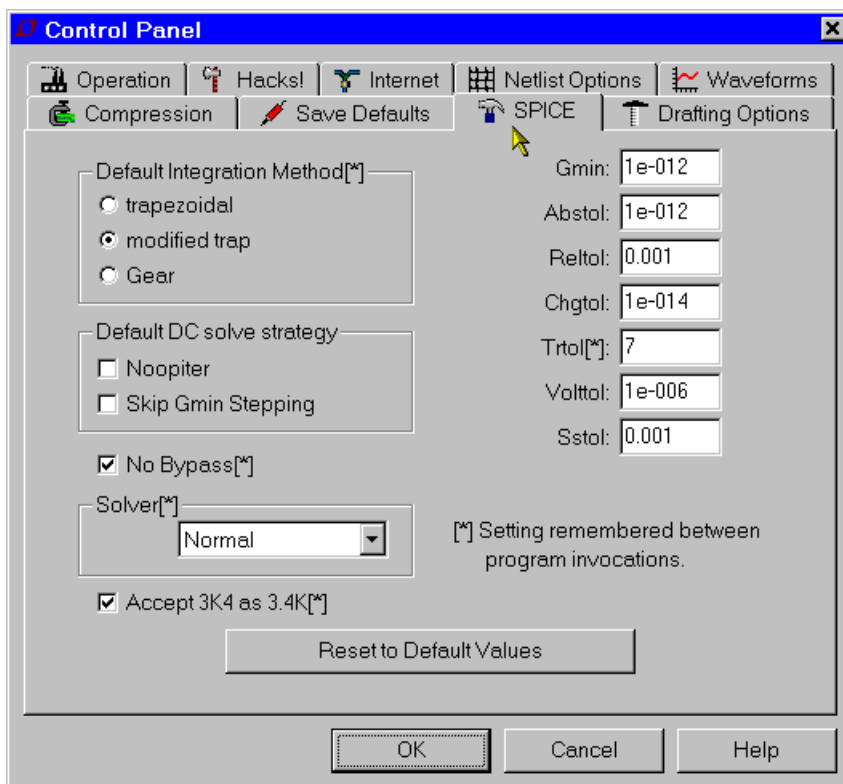

One default you may want to change is Trtol. Most commercial SPICE programs default this to 7. In LTSpice this defaults to 1 so that simulations using the SMPS macromodels are less likely to show any simulation artifacts in their waveforms. Trtol more affects the timestep strategy than directly affects the accuracy of the simulation. For transistor-level simulations, a value larger than 1 is usually a better overall solution. You

might find that you get a speed of 2x if you increase `trtol` without adversely affecting simulation accuracy. Your `trtol` is remembered between program invocations. However, most of the traditional SPICE tolerance parameters, `gmin`, `abstol`, `reitol`, `chgtol`, `vntol` are not remembered between program invocations. If you want to use something other than the default values, you will have to write a `.option` statement specifying the values you want to use and place it on the schematic or keep the settings in a file and `.inc` that file.

Also interesting is which solver is used. LTspice contains two complete versions of SPICE. One is called the normal solver and the other is called the alternate solver. The alternate solver uses a different sparse matrix package with reduced roundoff error. Typically the alternate solver will simulate at half the speed of the normal solver but with one thousand times more internal accuracy. This can be a useful diagnostic to have available. There is no `.option` to specify which solver is used, the choice must be made before the netlist is parsed because the two solvers use different parsers.

Check the box next to "Accept 3K4 as 3.4K" to force LTspice to understand a number written as 4K99 to be equal to 4.99K. Normal SPICE practice does not allow this, but it is available in LTspice by popular request.

## Netlist Options

**Convert 'μ' to 'u':** Replace all instances of 'μ' to 'u'. Useful if your MS Windows installation can't display a Greek Mu (as, e.g., some Chinese editions of Windows don't with default fonts) and (ii) generating netlists for SPICE simulators that don't understand the 'μ' character as the metric multiplier of  $1e-6$ .

**Reverse comp. order:** Circuit elements are normally netlisted in the order in which they were added to the schematic. Checking this box causes this order to be reversed.

**Default Devices:** Whenever a diode is used in an LTspice schematic, the default model statement `".model D D"` is added

to the netlist to suppress messages about using the default model. Unchecking this option suppresses inclusion of this line as well as the analogous model statements for bipolar, MOSFET, and JFET transistors.

**Default Libraries:** Whenever a diode is used in an LTspice schematic, the default library, standard.dio, is included in the simulation by a .lib statement. Unchecking this option suppresses inclusion of this library as well as the analogous library statements for bipolar, MOSFET, and JFET transistors.

**Convergence Aids:** For Internal program development use only.

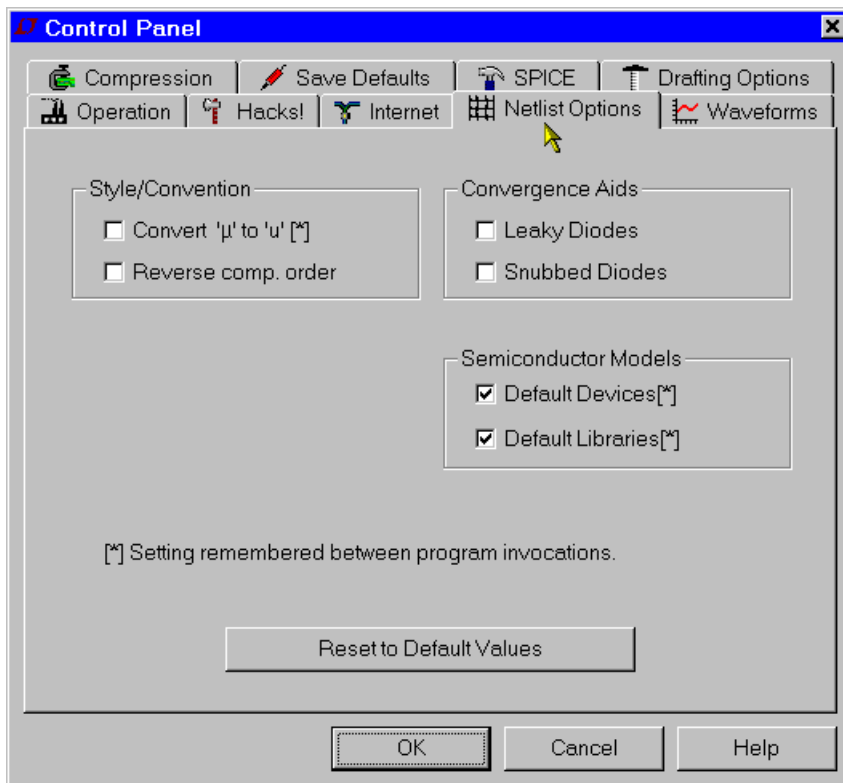

## Hacks

This pane was used for internal program development, but is currently almost obsolete.

Usually you can leave these options as they are. If you have frequently updated the program over the web, you might want to press "Reset to Default Values" to reset to the current recommended settings.

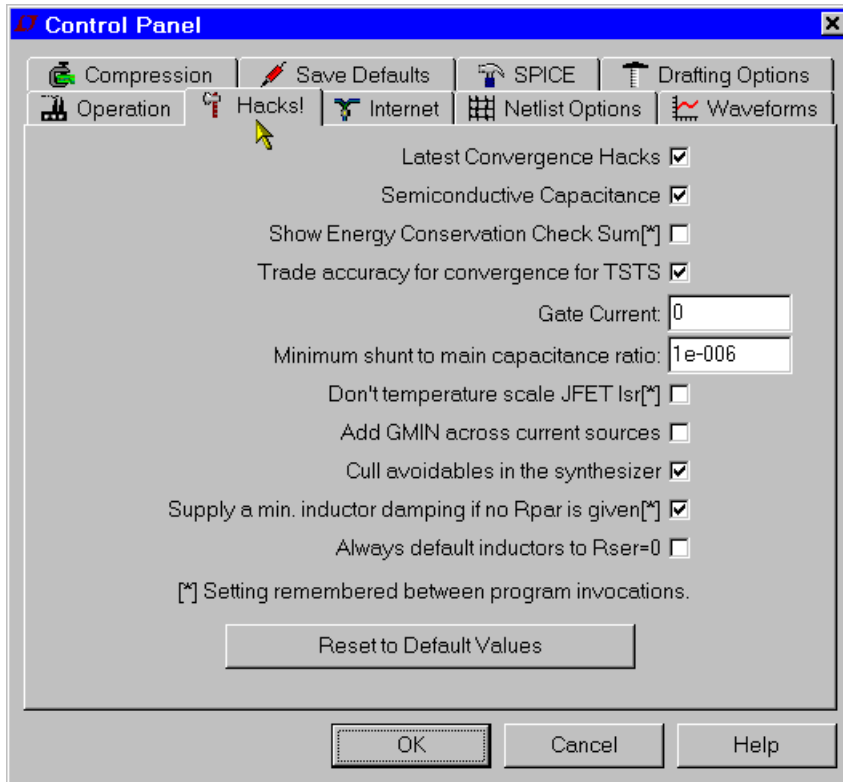

## Drafting Options

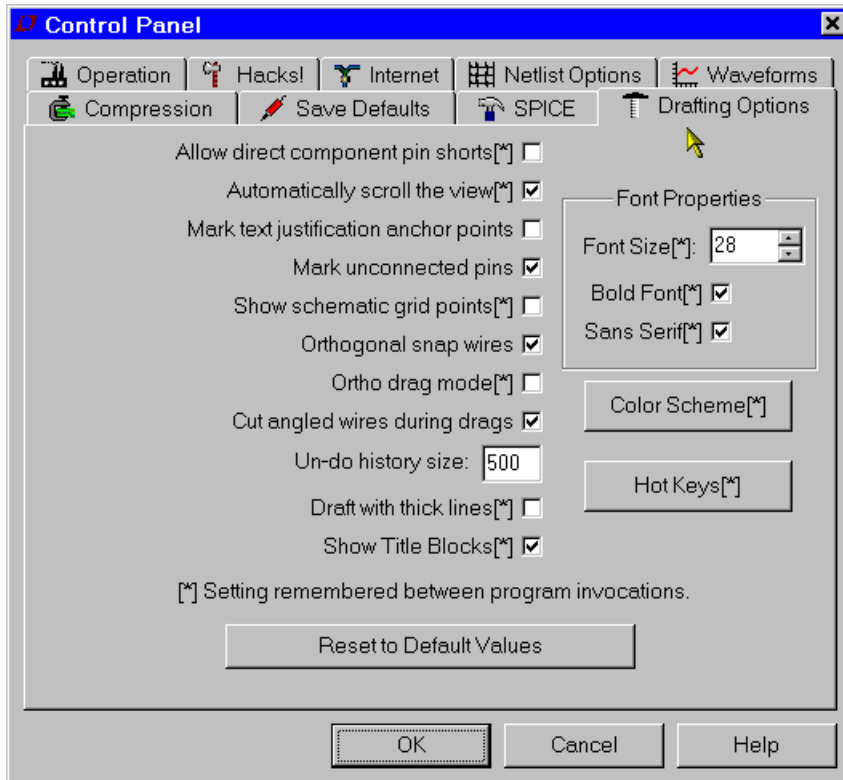

**Allow direct component pin shorts:** Normally you can draw a wire directly through a component and the wire segment shorting pins is deleted. If you check it, the shorting wire will not be automatically deleted.

**Automatically scroll the view:** Checking this box makes the view of the schematic scroll as you move the mouse close the edge while editing the schematic.

**Mark text Justification anchor points:** Draw a small circle to indicate the reference point of text blocks.

**Mark unconnected pins:** Draw a small square at each unconnected pin to flag it as unconnected.

**Show schematic grid points:** Start with visible grid enabled.

**Orthogonal snap wires:** Force wires to be drawn in vertical and horizontal segments while drawing. If not checked, a wire can be drawn at any angle and will snap to any grid. Holding down the control key will momentarily toggle the current setting while drawing wires.

**Cut angled wires during drags:** During the Drag command, a non-orthogonal wire will be broken into two connected wires if you click along the middle of the wire.

**Undo history size:** Set the size of the undo/redo buffer.

**Draft with thick lines:** Increases the all line widths. Useful for generating images for publication.

**Show Title Block:** For internal use.

## **Internet Options**

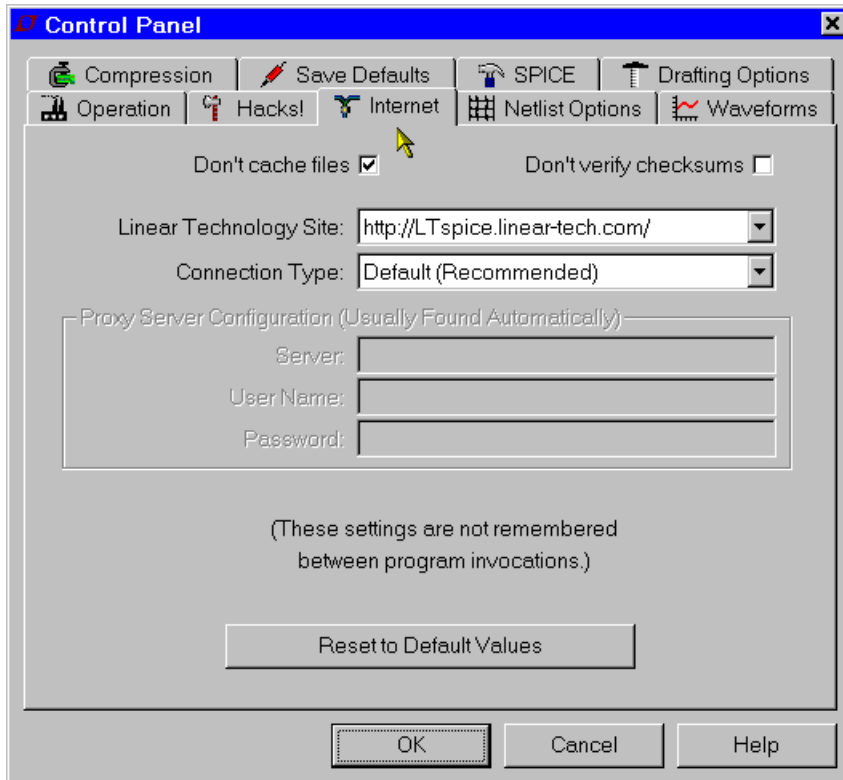

This pane of the Control Panel is used for the incremental updates obtained from the web. LTspice is often updated with new features and models. Use the menu command Tools=>Sync Release to update to the current version. If you don't update for a couple months, LTspice will begin to ask if you would like to check for updates. LTspice never accesses the web without asking for your permission to do so. LTspice contains no spyware or transmits any type of data while obtaining the files it need for update.

**Don't cache files:** Neither cache nor use files cached on our machine for the update.

**Don't verify checksums:** For security reasons, LTspice uses a proprietary and confidential 128bit checksum algorithm to authenticate the files it receives off the web for updating. This authentication can be disabled in case there's an error in that algorithm. However, no problem with this has ever been reported, so it is not recommended that you ever defeat this security feature.

LTspice uses only high-level operating system calls for its Internet access. It should not be required to make any adjustments to these settings except in rare cases when you need to specify the Proxy server and password since LTspice is not managing the Internet access, but your computer and operating system. Settings on this pane are not remembered between program invocations.

## **FAQs**

### **Installation Problems**

**How do I install LTspice IV?**

1. Go to <http://www.linear.com> and download the file LTspiceIV.exe into a temporary directory on your PC.
2. Execute the file LTspiceIV.exe to install. On Vista you will want to run this as Administrator.

**I'm running a Chinese Edition of Windows. The Greek Mu character doesn't show up correctly, what can I do?**

That problem should be completely fixed in the current version of LTspice IV. But you can go to the menu item Tools=>Control Panel=>Netlist Options and check "Convert 'μ' to 'u'". This option now not only applies to netlists, but will draw a Greek Mu as 'u' wherever it might appear on the screen.

### **Program Updates**

**How do I get the latest version?**

Once installed, there are two ways to getting the latest version. You can always reinstall the program again as mentioned in [Installation Problems](#). You don't have to remove the old



version before installing. If your PC has an internet connection, it is easier to get the latest release by using the [Sync\\_Release](#) feature, but not necessarily faster.

### **How do I know what new features are added?**

After you have updated your file to the latest version, the 'changelog.txt' file in your root directory, usually at C:\Program Files\LTC\LTspiceIV\Changelog.txt, has a detailed program revision list.

### **Can I go back to the old version after Sync\_Release?**

It is not reversible. All symbols, models, and programs are updated with the new ones. You need to make a backup copy before the Sync\_Release starts. The component databases, standard.\*, will be merged with the new ones automatically. If you added new inductors or capacitors, your devices will be preserved and merged with the new ones from program update. Your own local working file won't be affected.

## **Transformer Models**

### **How do I build a transformer model?**

The best way would be to draft a model with coupled inductors with a mutual inductance statement placed as a SPICE directive on the schematic. See the section on [mutual Inductance](#) for more information. Inductors participating in a mutual inductance will be drawn with a phasing dot.

The following example demonstrates a transformer with 1:3 turns ratio (one to nine inductance ratio) with a sine wave input and simulates for 0.1ms. The K is set to 1 to model a transformer with no leakage inductance.

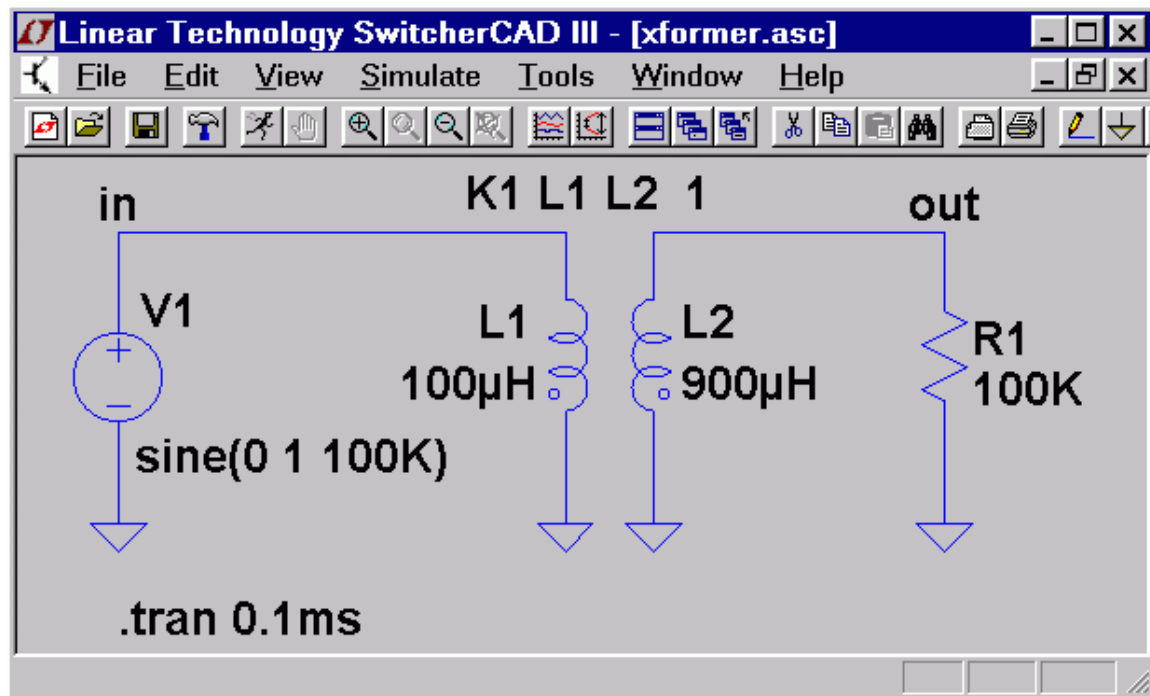

## Third-party Models

This section explains the basics to adding a third-party model to LTspice IV.

Basically there are two types of third party SPICE models, those described with a `.MODEL` statement and those defined with a `.SUBCKT`.

Models given as `.MODEL` statements are for intrinsic SPICE devices like diodes and transistors. The `.MODEL` statement gives the parameters for the specific component. The behavior of the device is already known by SPICE, only the parameters need to be given to finish specifying the component's electrical characteristics.

On the other hand, models given by `.SUBCKT` statements define the modeled component by a collection of circuitry of intrinsic SPICE devices. For example, the SPICE model of an opamp would be given as a subcircuit.

The way how to include the model in LTspice depends on whether the model is given as a .MODEL statement or a .SUBCKT.

Example for an NPN transistor defined with a .MODEL statement:

1. Add an instance of the symbol NPN to your schematic.
2. Edit the value "NPN" to be "BC547C" to coincide with the name used in the target .MODEL statement.
3. Now either
  - 3a) Add the .MODEL BC547C... statement as a SPICE directive on your schematic.

or

- 3b) If you have a file bipolar.lib containing your .MODEL BC547C... (other models may be too in this file), then add the SPICE directive ".INCLUDE bipolar.lib" on your schematic. Note that "bipolar.lib" must be the complete name with any file extensions and that Windows Explorer defaults to not showing the file extension. So you if you have a file called "bipolar.lib.txt", which you can edit/view in notepad, and Windows Explorer shows you the file exits as "bipolar.lib" The SPICE directive to include this file is ".inc bipolar.lib.txt" If you used, ".inc bipolar.lib" you will get an error message that that file can't be found.

or

- 3c) You can alternatively add the .MODEL BC547C... statement to the file typically installed as C:\Program Files\LTC\LTspiceIV\lib\cmp\standard.bjt. If you do that you will automatically see the model as a choice was editing the NPN transistor. If you edit this standard.bjt file outside of LTspice, you will have to restart LTspice for it to notice that the file has changed.

Example for a 5-pin opamp. This will be defined with a .SUBCKT statement:

1. Add an instance of symbol opamp2 to your schematic.

2. Edit the value "opamp2" to "TL072" on the schematic to coincide with the name of the .SUBCKT.
3. Either
  - 3a) Paste the ".SUBCKT TL072 ..... .ENDS" definition as one multi-line SPICE directive to your schematic.or
  - 3b) If you have a file called "TI.lib" containing the definition of subcircuit TL072(It will look like a line that starts out as ".SUBCKT TL072...") add the SPICE directive ".INCLUDE TI.lib" to the schematic.

It is possible to create a new symbol and program it to automatically include the necessary model for the simulation. See help section Schematic Capture=>Creating New Symbols.

Example for a 3-pin NPN transistor but defined with a .SUBCKT statement:

1. Add an instance of symbol NPN to your schematic.
2. Move the cursor over the body of the newly-placed NPN symbol instance. Press <Ctrl>RightMouseButton. A dialog box will appear. Change Prefix: QN to Prefix: X. This causes this instance of the symbol to netlist as a subcircuit instead of an intrinsic bipolar transistor.
3. Edit the value "NPN" to be "BFG135" to coincide with the name given on the .SUBCKT line.
4. Then either
  - 4a) Add the .SUBCKT BFG135 lines to your schematicor
  - 4b) If you have a file Phil.lib containing your .SUBCKT BFG135 .... (others may be too in this file) then you have to add a SPICE directive .INCLUDE Phil.lib

One aspect of adding a .SUBCKT model to LTspice is that you need have the symbol used to call the subcircuit and the model agree

on the same pin/port netlist order. The above examples assume the 3<sup>rd</sup> party model you're adding follows popular pin order conventions.

Further related information is in the help sections Schematic Capture and LTspice. The basic idea is that the schematic capture program generates a netlist that the simulator, LTspice reads. Any aspect of importing 3<sup>rd</sup> party models can be resolved by understanding SPICE netlist syntax and how the schematic capture program generates that syntax. There are also tutorials prepared on this topic archived at the independent users' group at <http://groups.yahoo.com/group/LTspice>.

## Inductor Models

### How do I design a coupled inductor?

You first draw at least two inductors and then define the K coefficient between the two inductors.

See [mutual inductance](#) section.

### How do I control the inductor parasitic resistance?

By default, LTspice will supply losses to inductors to aid SMPS transient analysis. For SMPS, these losses are of usually of no consequence, but may be turned off if desired. On the "Tools=> Control Panel=>Hacks!" page, uncheck "Supply a min. inductor damping if no Rpar is given" This setting will be remembered between invocations of the program. There is also a default series resistance of 1 milliohm for inductors that aren't mentioned in a mutual inductance statement. This Rser allows LTspice IV to integrate the inductance as a Norton equivalent circuit instead of Thevenin equivalent in order to reduce the size of the circuit's linearized matrix. If you don't want LTspice to introduce this minimum resistance, you must explicitly set Rser=0 for that inductor. This will require LTspice to use the more cumbersome Thevenin equivalent of the inductor during transient analysis.

### **Can I add/edit my own inductor model?**

Open the file typically installed as

```
C:\Program Files\LTC\LTspiceIV\lib\cmp\standard.ind
```

to add or edit inductor models.

## **MOSFET Models**

### **What is the difference between LTspice IV MOSFET and standard SPICE MOSFET models?**

Besides the standard SPICE MOSFET models, LTspice IV also includes a proprietary MOSFET model that is not implemented in other SPICE programs. It directly encapsulates the charge behavior of the vertical double diffused MOS transistor. This allows a power device to be modeled with an intrinsic VDMOS device LTspice instead of a subcircuit as in other SPICE programs. See [models](#) definition for details.

### **Can I add my own MOSFET models?**

Yes, you can add your own model in the

```
C:\Program Files\LTC\LTspiceIV\lib\cmp\standard.mos
```

file. This file is only for devices defined with a .model statement, not as subcircuits. If you want to use a subcircuit, follow the following steps:

1. Change the "Prefix" attribute of the component instance of the symbol to be an 'X'. Don't change the symbol, just the instances of the symbol as a component on a schematic. You can access this attribute by holding down the control key and right clicking on the body of the component.

2. Edit the "Value" attribute of the component to coincide with the name of the subcircuit you wish to use.

Add a SPICE directive on the schematic such as ".inc filename" where filename is the name of the file containing the definition of the subcircuit. Note that this must be the complete name with any file extension and Windows Explorer defaults to not showing the file extension. So you if you have a file called "mylib.sub.txt", which you can edit/view in notepad, and Windows Explorer shows you the file exists as "mylib.sub" The SPICE directive to include this file is ".inc mylib.sub.txt" If you used, ".inc mylib.sub" you will get an error message that that file can't be found.

**Is there a tool for generating native LTspice VDMOS MOSFET models instead of subcircuits?**

Yes! Hendrik Jan Zwerver developed a free VDMOS tool that is distributed from the Files section of the independent users' group <http://groups.yahoo.com/group/LTspice>.

**Who is Hendrik Jan Zwerver?**

The guy on the right:



## License and Distribution

**Can I re-distribute the software?**

Yes, you can distribute the software freely whether you are a Linear Technology customer or not. See the [license](#) section for more details. Technical support for non-Linear Technology customers is purely discretionary.

**Is it a shareware, freeware or demo?**



This program is not a shareware or a demo. It is fully functional freeware. The purpose of this software is to help our customers use our products. It can also be used as a general-purpose circuit design package with schematic capture and SPICE simulation. We do encourage students using the program to become familiar with the analog design process. We cannot guarantee support for non Linear Technology related program usage, but we'll fix all general program bugs and appreciate such reports. We do extensive in-house testing and believe the program has superior convergence capability. There are no known outstanding bugs.

### **Who can I contact at Linear Technology for help?**

For all software issues, e-mail [LTspice@linear.com](mailto:LTspice@linear.com).

For all hardware issues, such as additional application information for Linear Technology IC's, call Linear Technology application department at (408) 954-8400 during normal business hours.

## **Circuit Efficiency Calculation**

### **What is the difference between \*.APP and \*.ASC files?**

An APP file is a schematic file and has embedded control statements to help calculate efficiency and other product information. ASC file is the general schematic file without any hidden SPICE commands. ASC file is the more general and powerful file format. It is recommended that you save your own designs with a .ASC file name extension.

### **How can I get an efficiency report for my schematic?**

You need to add a ".TRAN <time> steady" statement on the schematic. The program will automatically detect the steady state by checking the internal state of the LTC macro-models. It doesn't work when LTC switching regulator part is absent. There must be exactly one Voltage source in the circuit. This will be identified as the input. There must be exactly one current source in the circuit. This will be identified as the load. After the simulation is done, you can select the 'Efficiency Report' under the 'View' menu to see the report on the schematic.

## **Custom Symbols**

**Can I create my own symbols?**

Yes, you can create your own symbols.

**How do I create my own symbol?**

Start with the menu command File=>New Symbol.

**Can I create my own switching regulator models?**

Not very easily. The switching regulator models that ship with LTspice IV use a new hardware description language and new intrinsic SPICE devices designed to encapsulate the behavior of LTC's switching regulator products. Even if you succeed in making a model with standard SPICE primitives, the simulation will run orders of magnitude slower. Note that some people have made such switching regulator models with standard SPICE devices. LTspice can run these models and will usually outperform the simulator for which they were targeted.

## **Memory Problems**

**How much memory do I need to run the program?**

You can basically run the LTspice IV if you can operate your Windows system. We have spent a great deal of effort in minimizing the memory requirement of this program. While a typical simulation might generate 8Gigabytes of raw data, that data will be compressed on the disk to 400Megabytes. To view a single trace would require less than 65Megabytes of RAM. Of course, the more memory the better the performance will be. Also, LTspice IV benefits from the improved memory performance of Windows NT and later operating systems, so you might consider upgrading operating system if you run out of memory. An x64 OS will be the best choice in this regard.

### **Where is the waveform stored during simulation?**

All the waveform data are stored on hard disk. Only the plotted traces are loaded into RAM. Turning off the marching waveforms can reduce the RAM memory requirement. Note that for most analysis types, there is no particular file size limit. You can generate and view .raw files that are very many Gigabytes in size.

### **What if I don't have enough disk space for long simulation?**

The waveform data has been compressed, but it is still proportional to the run time and the number of traces saved. The easiest way to save memory is to select desired traces for storing before the simulation starts.

### **OK, I've done everything and I'm still running out of memory. What can I do?**

During a transient analysis, you can interactively throw away the past waveforms by pressing the '0' key. That will retrigger the simulation time to t=0 as the present time.

## Model Compatibility

**Are the switching regulator models compatible with PSpice models and others?**

The LTspice SMPS macromodels are implemented in a combination of new proprietary native LTspice devices and/or a proprietary hardware description language. While it is possible, in principle, to develop generic SPICE or PSpice macromodels, the resultant simulation speed would not be viable. LTspice can, however, run PSpice semiconductor and behavioral models and is generally a much higher performance simulator, so you might move your Pspice simulations to LTspice. Many users upgrade from PSpice to LTspice.

## SPICE Netlist

**How do I create a SPICE netlist?**

A netlist can be created with any text editor capable of generating an ASCII file. You can view the SPICE netlist of any schematic in LTspice IV with the command View=>SPICE netlist. From this view you can copy the netlist to the clipboard by selecting all text and typing Ctrl-C to bring the netlist to a different editor.

**How do I run a netlist?**

Just open the text file first and then run it. LTspice IV will recognize the file as a netlist if it has file extension of ".cir"

## Exporting/Merging Waveform Data

Can I export the waveform data to other applications?

You can copy a plot as bitmap by making a waveform window the active window and typing Ctrl-C. Then, in an application that accepts bitmap pastes from the clipboard like Word or Paint, type Ctrl-V. Note that this also works for bitmaps of schematics. These images can also be exported as Windows metafiles(Menu command Tools=>Write to a .wmf file) which writes the image as vector graphics to a .wmf file that can be imported in various desktop publishing tools. When exporting a metafile of waveform data, you first go to Tools=>Control Panel=>Waveform=>Font and select Arial. The default, System, is highly legible on a CRT, but is a fixed font that does not scale correctly in metafiles.

OK, that works for bitmaps, but can I get the data itself to an application like Excel?

There is an export utility(Waveform Menu: File=>Export) that allows data to be exported to an ACSII file. There is also a 3<sup>rd</sup> party free utility written by Helmut Sennewald. It is available from the independent users' group <http://groups.yahoo.com/group/LTspice>. This utility allows various forms of manipulation of the data including the ability to merge waveforms from different simulation runs.

**Who is Helmut Sennewald?**

The guy on the right:



## Running Under Linux

Do you have a Linux version of this program?

Not a separate edition, but it does run under WINE. The program has been tested on Linux RedHat 8.0 with WINE version 20030219, RedHat 9.0 with WINE 20040716, and SuSE 9.1 with 20040716.

OK, I've never used WINE, how do I install this?

Check with <http://www.winehq.com> to find the current version of WINE for your system. At the time of this writing, for RedHat 8.0, this pointed to <http://mecano.gme.usherb.ca/~vberon/wine>

Copy the appropriate .rpm file to your machine and open it from nautilus.

Get the file LTspiceIV.exe from <http://www.linear.com>. In an xterm, execute "wine LTspiceIV.exe" to install LTspice.

There will now be a Linear Technology Logo on your gnome desktop. Double click it to start or type "wine LTspiceIV.exe" from an xterm to start the program.

### **The schematic fonts don't scale as smoothly under WINE as Windows. Why is that?**

WINE is doing the best it can with the fonts it finds. It will do better if you tell it how to find the files arial.ttf and cour.ttf from your Windows system.

### **The PWL additional point editor doesn't look right under WINE?**

Try using the native Windows .dll from your licensed Windows system. The command line to then invoke LTspice from WINE is `wine -dll commctrl,comctl32=n scad3.exe`.

### **It seems LTspice is running slightly differently under WINE/Linux than windows. Why is that?**

LTspice detects whether or not it's running under WINE. If so, it works around a few WINE issues. You can force LTspice to think it's running under WINE with the command line switch `-wine`. You can force it to think it's not with the command line switch `-nowine` in case you're interesting in working on WINE issues.

## **What about a Paper Manual?**

You can download a .pdf of these help pages from <http://LTspice.linear.com/software/scad3.pdf> and print it if you wish.

## **What about a Users' Group?**

There is an independent users' group at <http://groups.yahoo.com/group/LTspice>. The group has a Files section with additional tutorials, libraries, and examples.

## LTspice IV Overview

LTspice IV is a fourth generation switching regulator design program from Linear Technology. The program consists of a high performance SPICE simulator extended with a mixed mode simulation capability that includes new intrinsic SPICE devices for macromodeling Switch Mode Power Supply(SMPS) controllers and regulators. The program includes an integrated hierarchical schematic capture program that allows users to edit example SMPS circuits or design new circuits. An integrated waveform viewer displays the simulated waveforms and allows further analysis of the simulation data. There is a built-in database for most of Linear Technology's power ICs and many passive components. The device database, schematic editing, simulation control and waveform analysis are integrated into one program.

Due to the mixed mode simulation capability and many other enhancements over previous SPICE programs, the simulation speed is greatly improved while simulation accuracy is retained. Detailed cycle-by-cycle SMPS simulations can be performed and analyzed in minutes. A user can get a detailed simulation of power systems with a few mouse clicks without knowing anything about the device, SPICE or the schematic capture program. Pre-drafted demo circuits can be used as a starting point to build the custom circuit to fit different power supply requirements. After the new schematic is created, the system can be simulated and reports generated.

The program's integrated hierarchical schematic capture and SPICE simulator are available for general use. The improved performance of the SPICE simulation engine is a benefit for simulating general analog circuits and should be of interest to all electronic engineers. There are no arbitrary limits on component count or content. With an installed base of over 2,000,000 licenses so far, LTspice has arisen as the de facto standard SPICE simulator. We hope you enjoy the program and find it useful.



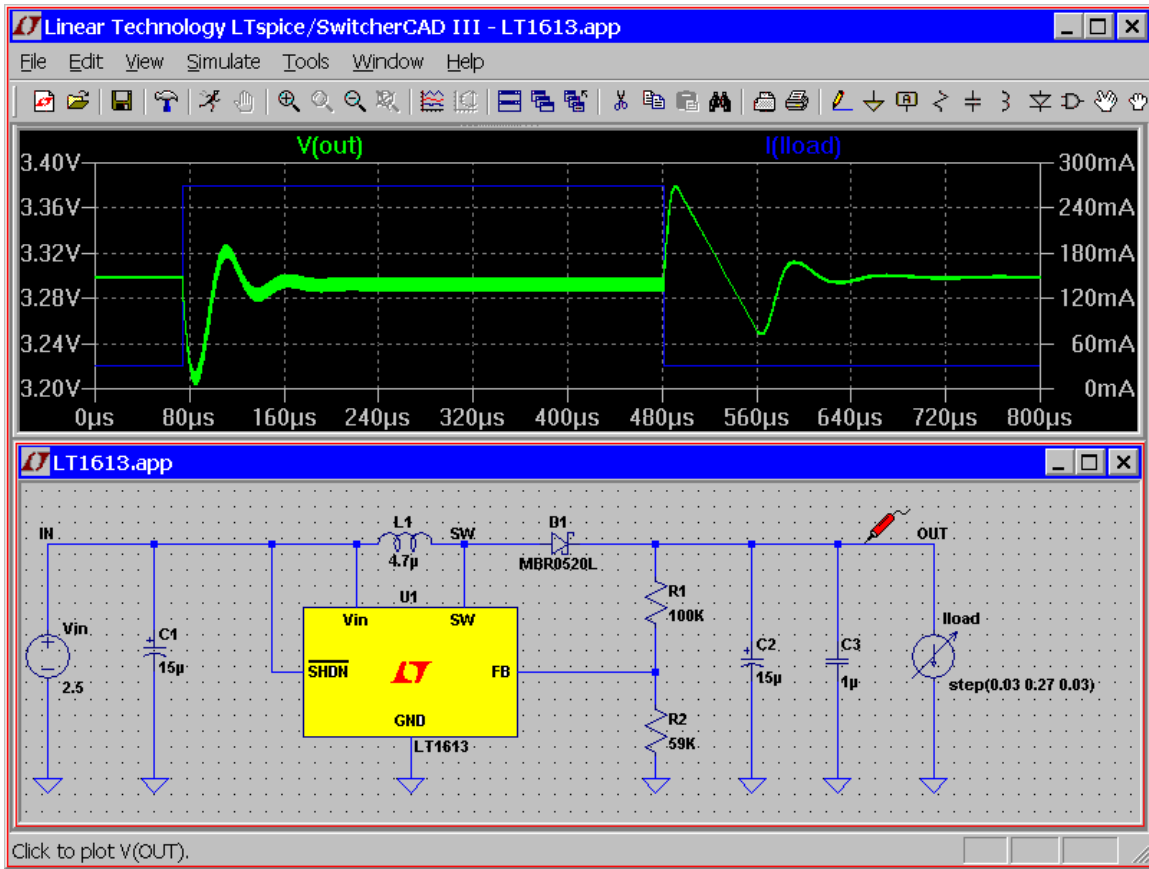

## SPICE Error Log Command

Use this command to display the simulation log file. A typical log file is shown as follows:

```
Circuit: * D:\XP\lib\app\LT1300-DC035A.app
```

```
Date: Tue Oct 05 16:57:31 1999
```

```
Total elapsed time: 6.64 seconds.
```

```
tnom = 27
temp = 27
method = modified trap
totiter = 14872
traniter = 14862
tranpoints = 3865
accept = 2986
rejected = 879
trancurters = 0
```

```
matrix size = 12  
fillins = 2
```

```
solver = Normal
```

## **Web Update**

All windows must be closed first before the Sync\_Release command can be activated. The user needs to establish the internet connection first. The LTspice IV program will then download the master index file(release.log) from the LTC web server. The master index file contains the checksums for every file in the sub-directories. The local file's checksum is then calculated and checked against the one in the master index file. The file on the web server will then be downloaded automatically if there is a difference in checksum. LTspiceIV program files that were saved under the same name will be overwritten! Most of the macromodels are less than 3KB and can be transferred in a few seconds. During the update of the SCAD3.EXE, the new file is first copied to the Windows temp directory and the old SCAD3.EXE is overwritten after the download is complete. The old program is still preserved if the user cancels the file transfer. The changelog.txt file lists the changes of program revisions.

# Index

.AC -- Perform an AC analysis .....	64
.BACKANNO -- Annotate the subcircuit pin names on to the port currents .....	65
.DC -- Perform a DC source sweep analysis .....	65
.END .....	66
.ENDS .....	66
.Ferret -- Download a File Given the URL.....	68
.GLOBAL -- Declare global nodes .....	68
.IC -- set initial conditions.....	68
.INCLUDE -- include another file.....	69
.LIB -- Include a library .....	70
.LOADBIAS -- Load a previously solved DC solution.....	73
.MEASURE -- Evaluate User-Defined Electrical Quantities .....	73
.MODEL .....	78
.NET -- Compute Network Parameters in a .AC Analysis.....	78
.NODESET -- supply hints for initial DC solution .....	79
.NOISE -- Perform a noise analysis .....	80
.OP -- Find the DC operating point .....	81
.OPTIONS -- Set simulator options .....	81
.PARAM -- User-defined parameters.....	85
.SAVE -- Limit the amount of saved data.....	90
.SAVEBIAS -- Save operating point to disk .....	90
.STEP -- Parameter sweeps .....	91
.SUBCKT -- define a subcircuit.....	92
.TEMP -- Temperature sweeps.....	93
.TF -- Find the DC small signal transfer function .....	94
.TRAN -- Do a non-linear transient analysis.....	94
.TRAN Modifiers .....	96
.WAVE -- Write selected nodes to a .wav file. ....	95

## A

A. General Structure and Conventions .....	59
A. Special functions. ....	98
Adding Attributes.....	28
Adding the Pins .....	27
Attached Cursors.....	50, 51, 54
Attribute Visibility .....	30
Automatic Symbol Generation.....	31
Axis Control.....	48

## B

B. Arbitrary behavioral voltage or current sources. ....	101
B. Circuit description. ....	58

## C

C. Simulator directives -- dot commands.....	63
C. Capacitor .....	107
Color Control .....	49

Command Line Switches .....	13
Compression.....	171, 172
Creating Symbol Overview .....	26
<b>D</b>	
D. Diode .....	110
Drawing the body.....	27
<b>E</b>	
E. Voltage Dependent Voltage Source.....	113
Edit a visible attribute .....	22
Efficiency Report .....	11
Example Circuits.....	8
Exporting Waveform Data .....	196
Externally Generated Netlists.....	10
<b>F</b>	
F. Current Dependent Current Source.....	115
Fast Access File Format .....	55
<b>G</b>	
G. Voltage Dependent Current Source.....	116
General Attribute Editor.....	24
General Purpose Schematic Driven SPICE.....	9
<b>H</b>	
H. Current Dependent Voltage Source.....	117
Hardware Requirements .....	5
<b>I</b>	
I. Current Source .....	118
III. Circuit Element Quick Reference.....	62
Is there a paper manual?.....	199
<b>J</b>	
J. JFET transistor.....	123
<b>K</b>	
K. Mutual Inductance.....	126
<b>L</b>	
L. Inductor.....	127
Label a node name .....	17
License Agreement/Disclaimer .....	6
LT Spice Overview .....	57
LTspice IV Overview.....	200
<b>M</b>	
M. MOSFET .....	132
Modes of Operation.....	8
<b>N</b>	
Navigating the Hierarchy .....	33

Netlist Options .....	178
<b>O</b>	
O. Lossy Transmission Line.....	143
Operation.....	173
Overview.....	32
<b>P</b>	
PCB Netlist Extraction.....	21
Placing Components.....	20
Plot Panes.....	48
Preface.....	4
Programming Keyboard Shortcuts.....	20
<b>Q</b>	
Q. Bipolar transistor .....	145
<b>R</b>	
R. Resistor.....	158
Rules of Hierarchy .....	32
Running Under Linux .....	198
<b>S</b>	
S. Voltage Controlled Switch.....	159
Save Plot Configurations.....	54
Schematic Colors .....	19
Schematic Editing .....	14
Software Installation .....	6
Specialized Component Editors .....	23
SPICE Error Log Command .....	201
Starting the Control Panel .....	171
steady .....	97
Symbol Editing .....	22
<b>T</b>	
T. Lossless Transmission Line.....	161
Trace Selection.....	35
tran .....	96, 97, 98
nodiscard .....	97
startup.....	96
step.....	98
<b>U</b>	
U. Uniform RC-line .....	161
User-Defined Functions .....	47
<b>V</b>	
V. Voltage Source .....	163
Viewer Overview .....	35
<b>W</b>	
W. Current Controlled Switch.....	167
Waveform Arithmetic .....	40
What about a Users s Group?.....	199

Windows Memory.....	56
<b>X</b>	
X. Subcircuit .....	169
<b>Z</b>	
Z. MESFET transistor .....	169
Zooming .....	40